

WATERPROOF INTELLIGENT INTERCOM



 **IWCS**
COMMUNICATION CAN SAVE LIVES



Content

Introduction - About IWCS	3
iriComm 4.0 wireless	5
iriComm 4.0 wired	9
Headset Attachments	10
Headset Options	11
Featured Products	12
Products	20
Intelligent Intercom	29
Research & Developing	39
Specifications	41
Radio Interfaces	47

Welcome to IWCS – About us

Clear and uninterrupted communication is in many cases a mandatory requirement for getting the job done, and especially in mission critical situations being able to communicate effortlessly and with both hands free is making a world of difference.

At IWCS we are dedicated to develop advanced and user-friendly solutions providing our professional customers trouble-free communication even under the most demanding conditions whether it is for SAR, Coast Guard or Tactical operations.

To position ourselves as a leading industry supplier, IWCS leverages the expertise within our team, both internally and through our Advisory Board. Our team boasts extensive industry experience, and we are deeply attuned to our customers' needs. Through active engagement with our clients, not only in discussions but also by actively participating in their operations, we have gained a profound understanding of their challenges. This enables us to craft the most innovative and effective solutions for their unique requirements, setting us apart in the market.

We are living in times when features and product development are not our only responsibility. We at IWCS are working with United Nations Sustainable Development Goals, in order to lift our share of the burden, of making the world a better place.

Co-Founder & CSO





iriComm 4.0 - Wireless



iriComm 4.0 will serve you day in and day out

Specifically developed for Rescue Swimmers and for use in loud surroundings with the best performance, iiriComm 4.0 has impressive specifications e.g. IP67 waterproof rating, and Noise Canceling Microphone that goes up to an impressive 142 dB SPL., which is necessary for helicopter use.

Working in rough conditions, as helicopter rescue swimmer, in tactical teams or fire departments, the importance of clear and uninterrupted communication at sea can not be underestimated. In many cases it is what separates success from failure. Weather conditions, surrounding noise, distance to team members – all factors potentially making clear communication difficult or impossible.

iriComm 4.0 comes in various configurations, and can be interfaced to external handheld radios, fixed radios, iiriSound Audio Mixers and even comes in a 2,4 GHz wireless version.



iriComm 4.0 is our brand new headset.

iriComm 4.0 Wireless works on the 2.4 GHz band and connects to iiriSound Solutions (Intelligent Intercom), to mobile phones and even Peer To Peer. iiriComm 4.0 supports two simultaneous connections at the same time.

iriComm 4.0 can be delivered with both headband or for helmet mounting

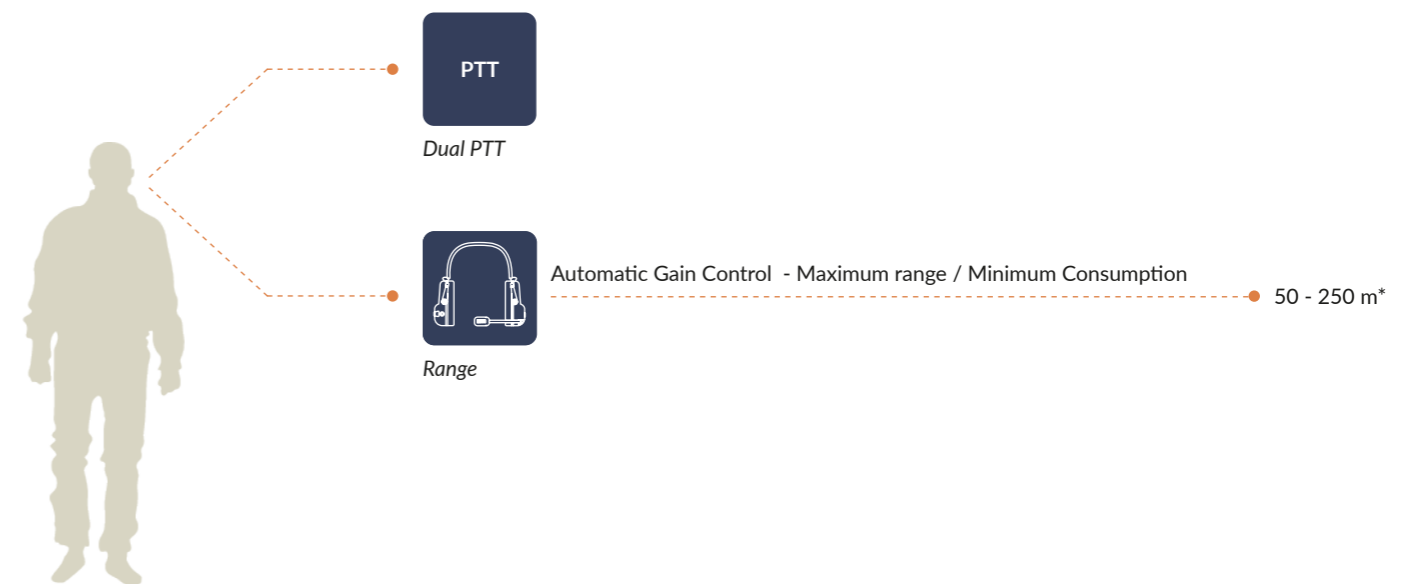

*Range depends on the surroundings and accesspoint.





Charging

When it comes to staying connected in challenging environments, the iriComm 4.0 wireless headset is your ultimate companion. With its impressive 15 hours of continuous use on a single charge, it ensures you're never left without communication when you need it most.

Charging your iriComm 4.0 is both quick and convenient. Thanks to its efficient design, it takes just 2 hours to fully charge the headset.

The charging port is cleverly located inside the right ear cup, ensuring easy access and protection from the elements. No need to fumble around or worry about exposed ports. Simply plug in your charger, and you're good to go.

Improved PNR

iriComm 4.0 takes passive noise reduction (PNR) to new heights. Our engineers have fine tuned every detail to ensure that unwanted noise is a thing of the past. Whether you're working in a noisy cockpit or outside in a noisy environment, your incoming communications will be crystal clear thanks to iriComm 4.0's improved PNR design. Don't just block out the noise; elevate your communication experience with iriComm 4.0.

Noise Canceling Microphone

iriComm 4.0 features a cutting-edge noise canceling microphone capable of handling deafening sound levels of up to 142dB. This means that even in the loudest of environments, your voice will come through with pristine clarity. Say goodbye to distorted or garbled communication and experience the pinnacle of sound quality with iriComm 4.0.



Connectivity

Used as a Stand Alone Headset iriComm 4.0 can connect to a Mobile Phone. Incoming calls can be answered directly from the headset and your podcast will be set on hold immediately. When either the caller or the user hangs up the call, the pod cast reconnects immediately.

In Peer To Peer setup, two iriComm 4.0 Headsets can have a simultaneous mobile phone connection. The two users will have Full Duplex Intercom. Any incoming phone calls can be accepted directly from the headset, and will, when accepted, disconnect the intercom as long as the phone conversation is ongoing. When a mobile phone call is hung up the Intercom mode is reactivated instantly.

In an iriSound Intercom set up with more than two users and maybe external radio connections, the iriComm 4.0 headset will provide Full Duplex Intercom to all users. External radios will be integrated in the solution and allow everybody to hear everything... Using an iriSelect - user defined groups can be defined.

Advanced Technology

iriComm 4.0 boasts state-of-the-art technology, including game-changing features like active noise reduction and situational awareness. Experience communication on a whole new level with advanced, adaptive solutions that make your environment work for you. Stay connected, stay aware, and stay in control with iriComm 4.0.

Voice Prompts

iriComm 4.0 Wireless has Voice Prompts which gives the user audible information when any change is made. Connections or lost connections, battery status, ON / OFF information, charge mode, pairing etc.



Headset to headset



Mobile



Intercom



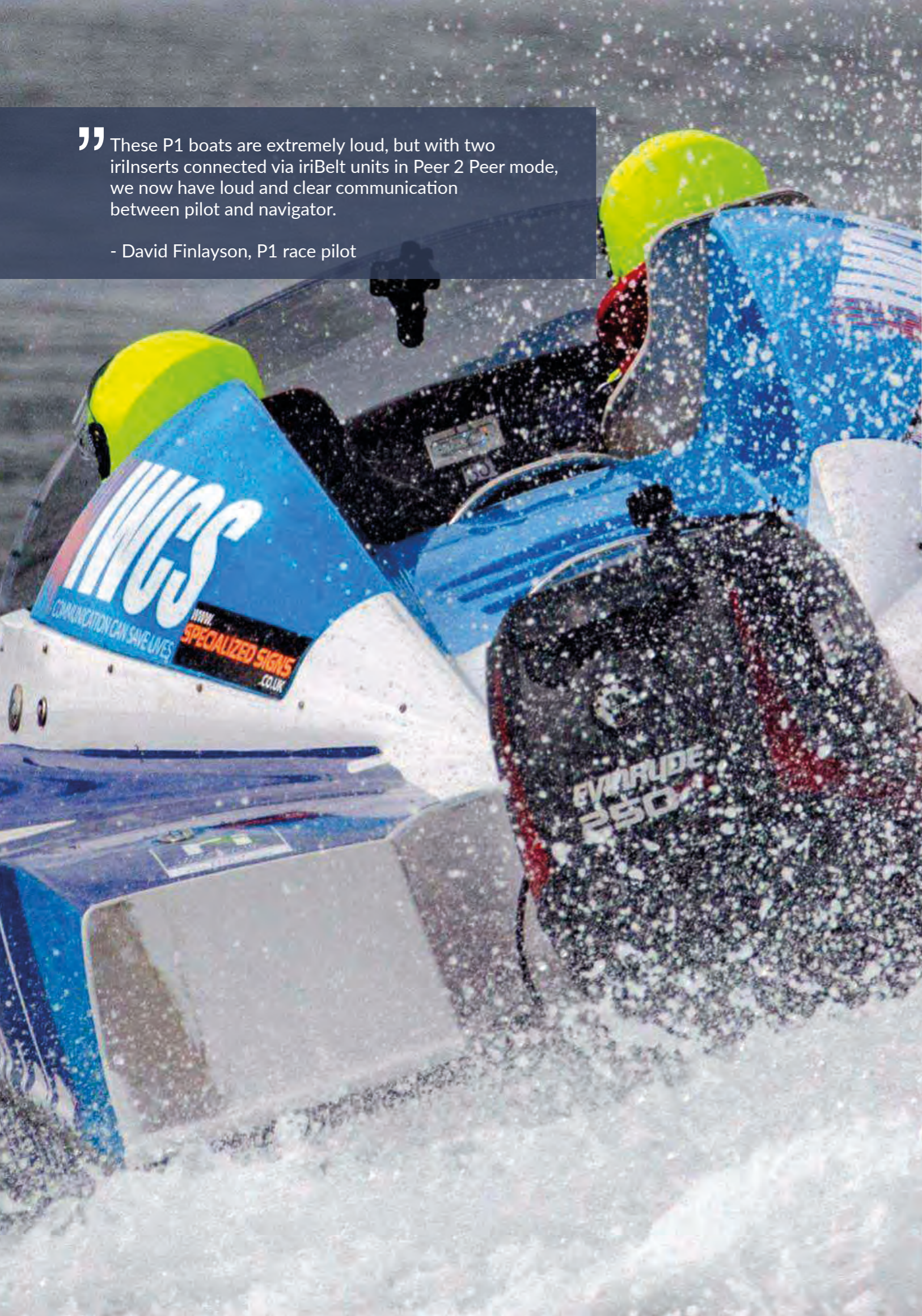

” These P1 boats are extremely loud, but with two iriInserts connected via iriBelt units in Peer 2 Peer mode, we now have loud and clear communication between pilot and navigator.

- David Finlayson, P1 race pilot

iriComm 4.0 - Wired



With its unique and improved design iriComm 4.0 is engineered to provide best in class audio quality under extreme conditions.

A completely sealed construction makes iriComm 4.0 just that ideal choice for those working in noisy, wet and salty environments. Our iriComm 4.0 headset comes with a radio-specific connector that matches your handheld radio or our own iriBelt MKIII.

Depending on radio model, attaching the headset may disable the radio's internal microphone and speaker. Volume control is handled by operating the radio's volume setting. PTT function on the headset is available to activate the radio for outgoing calls.

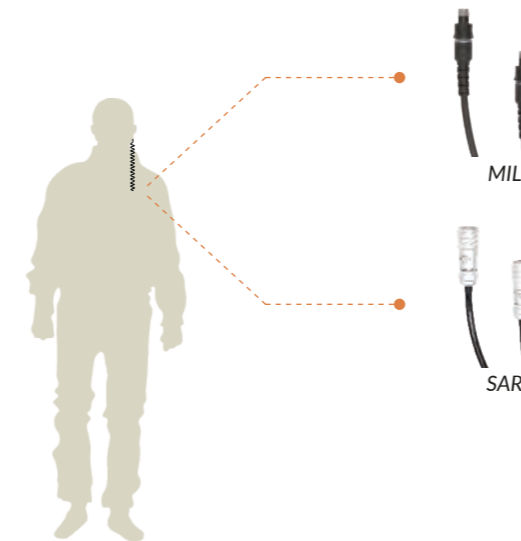

The iriHS communicates with iriSound, and the build-in amplifiers and digital volume control allow you to adjust the volume to exactly the desired level. The non-volatile memory will make sure your setting is remembered for next time the system is re-started.

With IWCS' headset connection panel you can attach your iriComm 4.0 headset directly to your on-board radio, giving you crystal clear audio and PTT on the headset while maintaining the fist microphone as backup.

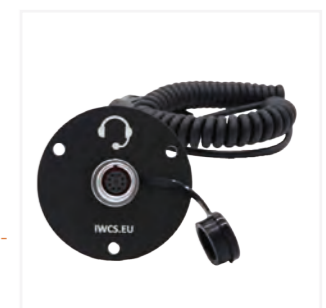



Attachment



Headband

The headband on the iriComm 4.0 is designed with user comfort and durability in mind. It is fully adjustable to ensure a secure fit on different head sizes, providing a warm and comfortable feel during extended wear. This ergonomic headband design increases user comfort, making it ideal for professionals in demanding fields such as search and rescue and military operations. The headband is so thin that most high-cut helmets can easily be used with the headset on.

Helmet

The helmet bracket for mounting the iriComm 4.0 is thoughtfully designed to provide secure and convenient attachment of the headset to helmets. With a semi-standard 88mm width, it's compatible with a wide range of helmet systems. This versatile bracket ensures easy integration, making the iriComm 4.0 a valuable tool for professionals who rely on headsets in challenging environments like aviation, maritime, and tactical operations.



Ear-pads

The ear-pads of the iriComm 4.0 are meticulously designed for optimal comfort and performance. These soft, cushioned pads ensure a snug fit and effective noise isolation, allowing you to stay focused in noisy environments. Whether worn for extended periods during long missions or daily tasks, the ear-pads provide the comfort and reliability you need. They're easy to clean and maintain, ensuring durability and hygiene throughout their use. With the iriComm 4.0, your communication experience is not only advanced but also exceptionally comfortable.

Wireless & Wired Plus



LED

This feature provides three very useful light modes. Dimmed mode provides sufficient light for reading a map held in your hands without causing too much disturbance of your night vision or the people in your vicinity.

High-beam mode lights up the path in front of you, and makes it possible to move around and navigate in total darkness.

In Strobe mode the LED continuously emits powerful flashes at a constant frequency helping others locate you in the dark. Even a mile or two away a helicopter without FLIR equipment will be able to easily locate your position.



3-Mode LED

Situational Awareness (SA)

SA mode makes it possible to have a "local" conversation and hear what is happening around you without removing the headset. When SA mode is enabled, sound from the intercom system or connected radio is attenuated by 24dB. This allows for monitoring intercom or radio traffic while engaging in "local" conversation.

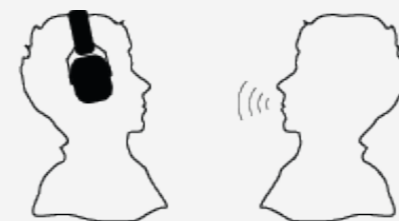



” In a three-way collaboration with Garmin and IWCS, Sjöräddningssällskapet is implementing user-friendly iriSound intercom across our new generation of rescue vessels.

- Jonas Carlsson, Head of New Vessel Design

iriSelect Black Box

The desire for a user-friendly, intuitive and clean instrument panel is solved easily and elegantly with the iriSelect Black Box, where the iriSound Intelligent Intercom is controlled via the vessel's or vehicle's existing Multifunction Functional Display (MFD). In addition to all the known iriSelect functions, the recording function via iriStore, mobile phone and hailer can now be easily controlled via the MFD.



The user interface is designed to auto-adapt to your specific Multi Function Display unit, and the system will auto-generate a screen layout that matches your specific intercom system configuration, considering number of connected radios and headsets etc. If the system is to be used on a fleet where all vessels are uniform and operated by many different users, a user-optimized design may be the solution. IWCS offers to design such customized layout.

In contrast to the standard iriSelect, where a fixed number of operational modes are pre-programmed into the device from the factory, iriSelect Black Box allows you to dynamically change voice groups, radio access rights etc. during a mission. The screen provides an intuitive, visual presentation of audio routing in the system, and changes take effect immediately. To prevent unintentional changes to settings, an optional PIN code protection can be enabled.



Your Intelligent iriSound Intercom System and iriSelect Black Box have many functions, and not all of them are used every day. For your convenience, the iriSelect Black Box contains both a Quick Guide and a more detailed user manual. On request, user-specific details and information can also be included.

Disclaimer: Graphics may vary from shown images





Headset Interface

This new design enhances operational flexibility by allowing users to manage volume and remotely control Push-To-Talk (PTT) across up to four radios, providing a highly adaptable communication experience. With an IP67-rated waterproof build, the interface is engineered to withstand challenging conditions while maintaining performance and reliability.

Powered by iriSound, the IWCS Intelligent Headset Interface delivers superior sound quality and is available with either a pigtail or flush connector option, giving users more versatility in setup and compatibility with existing systems.



Headset interface

- Volume Control.
- Remote PTT (Push-To-Talk)
- Waterproof Rating: IP67.
- Powered by iriSound.
- Connector Options: Pigtail or Flush Connector
- Built to withstand extreme conditions.
- Compatible with IWCS systems and other industry-standard communication setups.
- Selectable PTT for up to 4 radios.
- Indication of radio TX status.

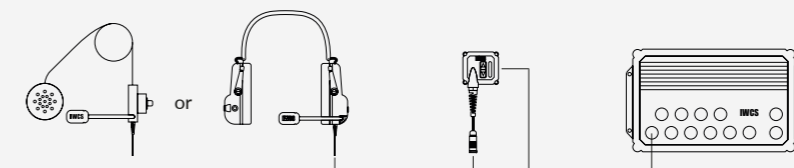



Active Splitter

The IWCS ACTIVE SPLITTER is the ultimate solution for aviation crews, addressing common requirements and enhancing communication capabilities. With the ACTIVE SPLITTER, easily connect two headsets using just one port on your ICS, effectively doubling your headset capacity. Enjoy full intercom functionality between the connected headsets, along with independent volume control for each. Additionally, the ACTIVE SPLITTER acts as an impedance matcher and signal amplifier, resolving compatibility issues between headsets and ICS. Each headset port on the ACTIVE SPLITTER is independently configured to accommodate specific headset types. Streamline your aviation communication setup with the versatile and efficient ACTIVE SPLITTER from IWCS



Active Splitter

The ACTIVE SPLITTER from IWCS addresses several commonly occurring requirements for aviation crews. It provides easy connection of two headsets while occupying only one port on your ICS, potentially doubling the headset capacity of your ICS. The ACTIVE SPLITTER creates full intercom between the attached headsets and offers independent volume control for each. The ACTIVE SPLITTER can also function as impedance matching and provide signal amplification for those situations where you run into incompatibility between headset and ICS. Each headset port on the ACTIVE SPLITTER is independently configured for the specific headset type. This model uses TP/TJ-108 connectors and thereby gets its power from the frame.

Active Splitter - Battery

This model offers the same functions and variants as the basic model - but is powered by 2 internal batteries. The aircraft types that do not use ANR in the helmets usually do not have power available in the individual plugs - this model can be used here.

This model uses TP/TJ-120 connectors.





iriBridge

iriBridge and iriBridge-R are aimed at solutions that do not require many users and great flexibility.

Both models are based on an analog mixer and allow 2 users to connect 2 x 2.4 GHz devices. It can both be an IWCS product such as iriComm or iriBelt, but many 3rd party products can also be used.

Whether it is a Jet ski with two people or two Jet skis with one person each. Whether it's an ATV, a snowmobile, a pleasure craft or something else entirely - then iriBridge can be the solution.



IriBridge

When working in a team, being able to communicate effortlessly will not only simplify solving the task at hand but it can also considerably improve the safety of the people involved. iriBridge was designed with teams of 2 people in mind, where there's a need to communicate over short to medium distances, where direct communication is otherwise challenging or impossible. With iriBridge you can connect two wireless headsets together, creating an always-open (full duplex) communication channel. For long-range communication, iriBridge-R offers a connection to an external radio.

iriBridge-R

iriBridge-R has the same basic functionality as the iriBridge, with the addition of a connection for an external communication radio.

The external radio makes it possible to communicate over longer distances. When used with an iriComm headset, remote PTT function for the external radio is supported. Alternatively, a separate PTT button can be connected to iriBridge-R. iriBridge-R can be ordered for specific radio models.

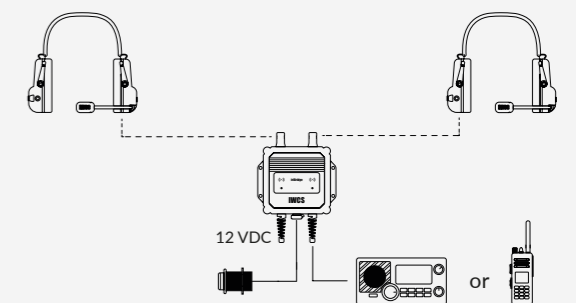
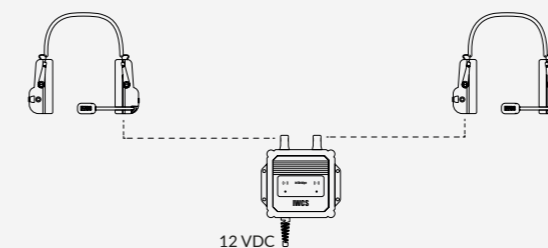



” The communication between the paramedic, the patient, the relative and the driver can be enhanced significantly with iriSound Intelligent Intercom.

- Lars Haagh / CTO and Co-Founder of IWCS
Communication can save lives

iriBelt III

When none of our fully wireless iriComm 4.0 solutions match your requirements, iriBelt can be the unit that brings you fully wireless. iriBelt connects to an IWCS Wired headset or to an iriInsert speaker/ microphone combo, which is designed to fit in a Gecko MK11 marine safety helmet. For other helmet types, please contact us to hear about the possibilities.

iriBelt in combination with a wired headset, gives you the same functionality as a wireless iriComm headset. iriBelt MKII has two PTT buttons enabling remote activation of up to two external radios. Improved operational range with normal/long-range capabilities.

iriBelt is charged inductively.

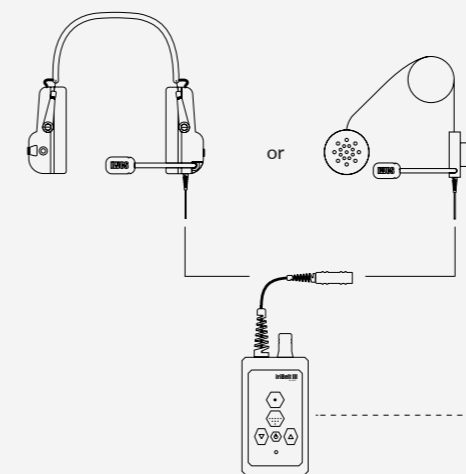

Features

- Fully waterproof, IP67
- Voice prompts
- Connects to the iriInsert speaker/ microphone combo
- Connects wireless to an iriConnect
- Connects wireless to another iriBelt or any iriComm
- >18 hours operation between charges



Products



iriComm 4.0 - Wireless

iriComm 4.0 is our brand new rugged and waterproof headset, with Situational Awareness and 3-mode LED light. Specifically developed for Rescue Swimmers and for use in loud surroundings with the best performance. iriComm 4.0 has impressive specifications e.g. IP67 water-proof rating, improved PNR and a Noise Canceling Microphone that goes up to an impressive 142 dB SPL.

- IP 67 Waterproof
- Dual PTT
- Noise canceling mic. (max. SPL 142 dB.)
- Run Time above 12 hours*
- Situational Awareness
- 3-Mode LED
- Part number: IR-35-2112-01-xxxxx



iriComm 4.0 - Wired

iriComm 4.0 is our brand new rugged and waterproof headset, with optional Situational Awareness and 3-mode LED light. Specifically developed for Rescue Swimmers and for use in loud surroundings with the best performance. iriComm 4.0 has impressive specifications e.g. IP67 waterproof rating, improved PNR and a Noise Canceling Microphone that goes up to an impressive 142 dB SPL.

- IP 67 Waterproof
- PTT
- Noise canceling mic. (max. SPL 142 dB.)
- Part number: IR-35-1111-01-xxxxx



iriComm 4.0 - Wired PLUS

iriComm 4.0 is our brand new rugged and waterproof headset, including Situational Awareness and 3-mode LED light. Specifically developed for Rescue Swimmers and for use in loud surroundings with the best performance. iriComm 4.0 has impressive specifications e.g. IP67 waterproof rating, improved PNR and a Noise Canceling Microphone that goes up to an impressive 142 dB SPL.

- IP 67 Waterproof
- PTT
- Noise canceling mic. (max. SPL 142 dB.)
- Situational Awareness
- 3-Mode LED
- Part number: IR-35-1112-01-xxxxx

iriSound 4 MKII

iriSound 4 is intended for a smaller vessel with a crew of 2-3 people, where there is probably only one external radio installed.

- Up to 4 audio/intercom ports for crew-members or external radios
- 2 AUX ports for connection of external equipment like iriSelect, iriBoost or iriStore
- 400MHz DSP core delivering impressive sound quality at 24bit/48kHz sampling
- Advanced noise canceling/muting feature
- Preconfigured side tone suppression
- Fully waterproof design
- Built-in power supply noise filter
- Power supply 12VDC/2A
- Part number: IR-14-0300-01



iriSound 6 MKII

iriSound 6 is intended for the medium sized vessel with a crew of up to 4 or 5 people, or where several external radios are used.

- Up to 6 audio/intercom ports for crew-members or external radios
- 2 AUX ports for connection of external equipment like iriSelect, iriBoost or iriStore
- 400MHz DSP core delivering impressive sound quality at 24bit/48kHz sampling
- Advanced noise canceling/muting feature
- Preconfigured side tone suppression
- Fully waterproof design
- Built-in power supply noise filter
- Power supply 12VDC/2A
- Part number: IR-16-0300-01



iriSound 8 MKII

iriSound 8 is intended for the larger vessel with a crew of 5 or more people, and/or where several external radios are used.

- Up to 8 audio/intercom ports for crew-members or external radios
- 2 AUX ports for connection of external equipment like iriSelect, iriBoost or iriStore
- 400MHz DSP core delivering impressive sound quality at 24bit/48kHz sampling
- Advanced noise canceling/muting feature
- Preconfigured side tone suppression
- Fully waterproof design
- Built-in power supply noise filter
- Power supply 12VDC/2A
- Part number: IR-18-0300-01



iriSelect

iriSelect is an intelligent, helm-mounted, multi functional control and status unit.

iriSelect acts as the system controller for your iriSound intercom system. From here you control audio routing, noise canceling profiles, radio access and more. iriSelect also provides status information of up to 4 connected radios.

- Quad front-mounted PTT buttons + mode switch button.
- Numeric LED display for mode status indication
- Radio status indication for up to 4 connected radios
- Switching between pre-defined operating modes (audio segmenting / talk groups)
- Adaptive Voice Activity Detection – AVAD
- Activation of system “stealth mode”
- Indication of lost connection to wireless units
- Error indications
- Part number: IR-20-1040-02





iriSelect Black Box

Easily solve the need for a user-friendly and intuitive instrument panel with the iriSelect Black Box. Control the iriSound Intelligent Intercom seamlessly through your vessel's or vehicle's existing Multifunction Display (MFD). Experience the convenience of managing all iriSelect functions, including recording via iriStore, mobile phone and hailer, right from your MFD. Simplify your communication setup with the iriSelect Black Box and optimize your control interface.

- Part number: IR-20-1043-01



iriConnect - Internal Antenna

iriConnect is a digital Audio/Data access point for any wireless connections.

- 2.4 GHz Connectivity
- Powered by iriSound
- IP 67 Waterproof
- Available with REAR or BOTTOM cable connection
- Part number: IR-20-1050x-0x



iriConnect - External Antenna

iriConnect external antenna is a digital Audio/Data access point for any wireless connection. The external 2.7dBi antenna provides a uniform 180 degree coverage field (must be mounted in a vertical position).

This unit is fully waterproof and can be mounted on a targa-frame or bimini top.

- 2.4 GHz Connectivity
- Powered by iriSound
- IP67 Waterproof for outside installation
- Available with REAR or BOTTOM cable connection
- Part number: IR-20-1053x-0x



iriConnect - External Antenna Connection

iriConnect with external antenna connection is a digital Audio/Data access point for any wireless connection.

The RPTNC connector facilitates the connection to a external antenna of choice or a DAS (Distributed Antenna System) - possibly including sections of radiating cable.

Due to the limited corrosion resistance of the RPTNC connector, this unit must be mounted in a protected environment.

- 2.4 GHz Connectivity
- Powered by iriSound
- IP67 Waterproof but outside installation is not recommended
- Available with REAR or BOTTOM cable connection
- Part number: IR-20-1051x-0x

Radio Interface

IWCS External Radio Interface facilitates simple audio integration of external radios (or other audio sources) with your iriSound waterproof intercom system.

The Radio Interface is configurable to work with any commercially available radio as long as it has an external audio and PTT interface. When ordering, please specify the make and model of radio, and we will pre-configure the unit with the right settings and physical connector. We recommend using radios from one of our partners: Motorola, Sepura, Garmin, ICOM, Entel or Sailor, but the External Radio Interface is not restricted to working with these.

- Microprocessor controlled PTT function via iriSound and iriSelect
- Direct PTT interface for simple, flush-mount PTT (IR-22-1016R-01)
- Flexible/configurable radio interface
- Works with both balanced and single-ended audio interfaces
- Built-in bi-directional volume control
- Power supply via iriSound
- Multi-color status LED
- Part number: IR-20-1071-03-xxxx

iriStore

iriStore is an audio recorder for all communication from your iriSound Intercom System. iriStore is powered directly from iriSound and default records any RX/TX from all users / radios. If an iriSelect is a part of the setup the recordings can be limited to any preset. Multiple iriStores can be connected for group recordings.

iriStore uses a USB stick and handles up to 32 MB / 300 hours

- Part number: IR-1100-01

Headset Interface - Flush connector

IWCS Intelligent Headset Interface

- Volume Control
- Remote PTT for up 4 radios
- Fully waterproof design - IP67
- Powered by iriSound
- Part number: IR-20-1420-01-xxxx

Headset Interface - Pigtail

IWCS Intelligent Headset Interface

- Volume Control
- Remote PTT for up 4 radios
- Fully waterproof design - IP67
- Powered by iriSound
- Part number: IR-20-1420-01-xxxx





iriBoost

iriBoost is an intelligent 100W CLASS D amplifier that can drive a powerful loudhailer. All iriSound models are equipped with 2 AUX ports capable of outputting superior sound quality. By connecting iriBoost to a spare AUX port, your loudhailer becomes an integrated part of your iriSound Intercom system using the headset microphones. If your iriSound Intercom system includes an iriSelect, it is possible to configure the settings so that only selected users can speak on the hailer. It is even possible to activate the loudhailer wireless from an iriComm headset—e.g. while standing out on the deck.

- Part number: IR-20-1220-01

Headset connection panel

Moving at full throttle over ocean swells, with gale force winds and the roar of twin outboard engines, doesn't make hearing the onboard radio any easier. With IWCS' headset connection panel you can attach your iriComm 4.0 headset directly to your onboard radio of choice. Giving you crystal clear audio and PTT on the headset or fist microphone. This allows you to keep the throttle on and the mission go, for increased efficiency and speed of resolution. Obs! Connection plug may differ depending on host radio.



- IP 67 waterproof
- Easy mounting
- Can be modified to fit any on-board radio with a rear interface
- Rugged IWCS design
- Aluminum salt water resistant build quality
- Part number: IR-40-4011-0x-xxxx

iriBridge

iriBridge is intended for small vessels, jet skies, ATVs etc. with a crew of max. 2 and no radio integration is required. iriBridge can also be used on larger boats where a simple, wireless person to person connection is required.



- 2 Wireless headset channels for connection of headsets
- Fully analog audio design
- Preconfigured side tone suppression
- Fully waterproof design (with sufficient protection of antenna connectors)
- Simple headset pairing with 3rd party headsets
- Power supply 5VDC/200mA (USB connector)
- Part number: IR-20-1061-01

iriBridge-R

iriBridge is intended for small vessels with a crew of max. 2 and no radio integration is required. iriBridge can also be used on larger boats where a simple, wireless person to person connection is required.



- 2 Wireless headset channels for connection of headsets
- 1 radio interface with separate PTT connection (PTT ordered separately)
- Fully analog audio design
- Preconfigured side- tone suppression
- Fully waterproof design (with sufficient protection of antenna connectors)
- Simple headset pairing with 3rd party headsets
- Power supply 5VDC/200mA (USB connector)
- Part number: IR-20-1061-01-xxxx

iriInsert

- iriInsert is a rugged helmet insert, containing an IP 68 boom mic and IP67 waterproof speakers.
- iriInsert can easily be installed in either Gecko helmets or any other feasible helmet.
- Dual or single-sided
- Left or Right side microphone of your choice
- Part number: IR-33-00xxx-0x-xxxx



iriBelt MKIII

When none of our fully wireless iriComm 4.0 solutions match your requirements, iriBelt can be the unit that brings you fully wireless. iriBelt connects to an IWCS Wired headset or to an iriInsert speaker/microphone combo, which is designed to fit in a Gecko MK11 marine safety helmet. For other helmet types, please contact us to hear about the possibilities. iriBelt in combination with a wired headset, gives you the same functionality as a wireless iriComm headset. iriBelt MKII has two PTT buttons enabling remote activation of up to two external radios. Improved operational range with normal/long-range capabilities. iriBelt is charged inductively.



- Fully waterproof, IP67
- Wireless
- Voice prompts
- Connects to the iriInsert speaker/microphone combo
- Connects wireless to an iriConnect
- Connects wireless to most Wireless-enabled mobile phones
- Connects wireless to another iriBelt or any iriComm 4.0 unit in twin-com mode
- >18 hours operation between charges
- Part number: IR-20-2012OBK-01-xxxx

Active Splitter

The ACTIVE SPLITTER from IWCS addresses several commonly occurring requirements for aviation crews. It provides easy connection of two headsets while occupying only one port on your ICS, potentially doubling the headset capacity of your ICS.



- Connections: TP-108 (ICS) / 2x TJ-108 (Headsets)
- Wiring: NATO-US/Savox/Peltor
- Supply voltage: 24-32VDC (28VDC Nom)
- Mic. amp.: Configurable 0-60dB
- Waterproof: IP54
- Part number: IR-46-TX108-01-xxx

Active Splitter - Battery

The ACTIVE SPLITTER - BATTERY was developed to meet the requirements in airframe communication systems not providing power to each headset outlet. Similar to the ACTIVE SPLITTER, it provides easy connection of two headsets while occupying only one port on your ICS, potentially doubling the headset capacity of your ICS.



- Connections: TP-120 (ICS) / 2x TJ-120 (Headsets)
- Volume control: Independent for each output
- Wiring: Configurable NATO/Savox/Peltor
- Supply voltage: 2x 1.5V, size AA
- Mic. amp.: Configurable 0-60dB, dynamic or amplified
- Waterproof: IP54
- Part number: IR-46-TX120-01-xxx



Products

Audio/Data Cable

Interface cables between iriSound and fixed interfaces.

- 1,0 m
- 2,5 m
- 5,0 m
- 7,5 m
- 10,0 m
- 15,0 m
- Customer length
- Part number:



Power Cable

12VDC power cable for iriSound. (1,5 m. included with iriSound)

- 1,5 m
- 5,0 m
- Customer length
- Part number:



iriSound interconnect Cable

Required when Daisy Chain two or more iriSound units.

- 1,0 m
- Customer length
- Part number:



PTT

Recommended for Radio Interface

- 1,5 m
- Customer length
- Part number:



PWR/PTT for iriBoost

Required for iriBoost

- 1,0 m
- Customer length
- Part number:



” Having years of experience with IWCS intercom in our boats and small vehicles it was obvious to implement intercom in our large trucks.

- Fire Chief / Claus Larsen - NSBV

Intelligent Intercom

The importance of clear and uninterrupted communication at sea can not be underestimated. In many cases it is what separates success from failure. Weather conditions, surrounding noise, distance to coworkers – all factors potentially making clear communication difficult or impossible.

The iriSound system combines your existing VHF/UHF radios with a State-Of-The-Art, waterproof intercom system enabling clear and trouble free communication under the most demanding conditions.

iriSound is a highly advanced audio unit that processes all sound signals to and from external units whether they are headsets, external radio units or the iriVision camera documentation system. The built-in intelligence allows for easy plug-and-play installation when used with other Iridium products – like the iriConnect for wireless headset communication.

iriSound's rugged, cast aluminum enclosure and the IP67-rated connectors offer a fully waterproof exterior construction designed specifically for the harsh conditions on board small and medium sized vessels, with freedom to install it either inside or outside.

The electronics design is based on the newest 24bit/48kHz Digital Signal Processing (DSP) technology, which offers superior sound quality and a world of software features like dynamic noise reduction, user controlled voice groups etc., some of which are offered as additional features.

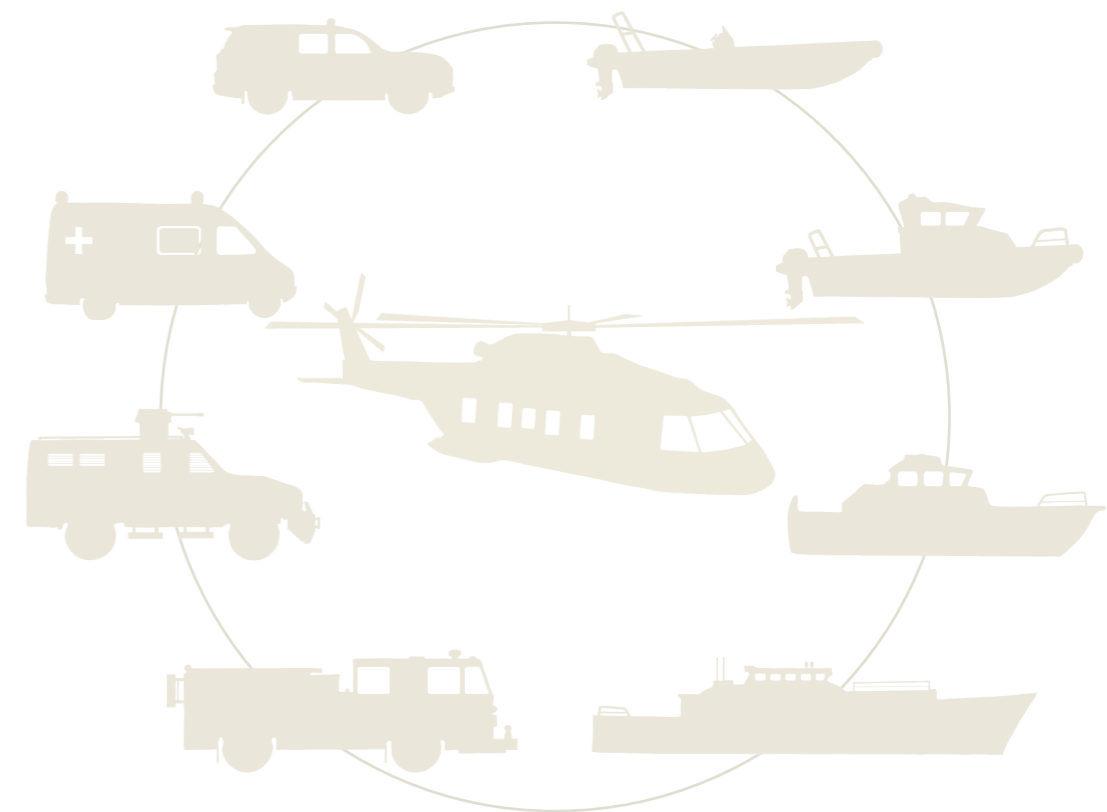

Modular



Crew members wearing either a helmet with irilnert or a wired iriComm 4.0 headset connected into a headset connection panel and radio.

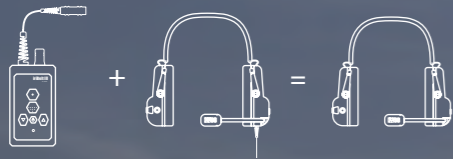

Crew members wearing an iriBelt in combination with either a helmet with irilnert or a wired iriComm 4.0 headset .



Wireless iriComm 4.0 headset or iriBelt connected directly to a mobile phone while also connected to intercom.



Crew members wearing either a helmet with irilnert or a wired iriComm 4.0 headset connected into our Headset Interface.

The heart of the intelligent intercom is the iriSound unit itself, combining a DSP controlled mixer unit with audio from user headsets and external radios. No compromise, high quality components, advanced technology in a rugged and waterproof design, give you a professional and reliable platform. Packed with advanced features such as noise compression, automatic squelch levels and high-end military grade noise canceling microphones, ensures you no longer miss out on vital communication. We have made the iriSound ready to go - right out of the box - so you're good to go.

The iriSound Intelligent Intercom system is modular and scalable giving you the freedom to expand your setup when needed. You can start with a few users on either wired or wireless headsets in a closed intercom system. If your needs exceed more than 10 audio channels, simply connect more iriSound units to the system. iriSound supports multiple external radios, audio recorders, external hailers, user defined grids and more.





User Interfaces

During normal use of the iriSound intercom system, the crew will not need to push any buttons - except maybe volume control and PTT when speaking on the external radios. This functionality is handled on the iriComm 4.0 wireless headset itself, or on the iriHS for wired headsets. The additional functionality of the iriSound system is controlled via iriSelect.

iriSelect

iriSelect is the optional user interface for your iriSound intercom system. iriSelect provides access to hidden features of the system, which are otherwise not accessible to the user. See below for details.

Headset Interface

The iriHS is used when you prefer a wired connection between your headset and the intercom system. iriHS provides volume control for the attached headset as well as PTT function for up to 4 connected radios.

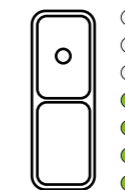
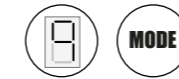
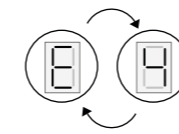

Volume mode

In volume control mode, the two buttons function as "Volume UP" and "Volume DOWN". Actual volume is indicated by a row of LEDs.

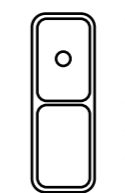

PTT mode

The iriHS can be switched into PTT mode, where the user can select one of up to 4 connected radios. PTT function can be activated both on iriHS itself and on the connected headset.

Dimmer

iriSelect has a built-in light sensor, that automatically adjust the LED light to a comfortable level. The light will be adjusted at iriSelect, headset interface and radio interfaces.

Stealth/NVG

The standard iriSelect adapts to surrounding light levels by dimming all indicator LEDs accordingly. For users of Night Vision Goggles (NVG) this is typically not sufficient, and the NVG-compatible version is required.

PTTs with RX/TX indication

The PTT will activate TX on the selected radio. TX indicator lights up when the selected radio Transmit. If more than one PTT is connected to the radio interface, the indicator will light up no matter which PTT is activated. RX indicator lights up when the selected radio receives incoming voice.

RX/TX control of up to 4 radios

iriSelect has 4 radio PTTs, each with both RX and TX indication. Both RX and TX indications are normally OFF. Each PTT will only be functional, if the corresponding Radio Interface and external radio is connected.





Helicopter

iriComm 4.0 is specially developed and designed for the use by a helicopter rescue swimmer, taking into consideration water- proof for seawater and RX /TX in extreme loud surroundings. During development a couple of other useful features have been added, and today iriComm 4.0 is a unique multi functional tool which combines high quality sound with user friendly controls among many other features.



Ambulance

During an emergency drive there is a lot of noise from both sirens, wind and the engine ... all at the same as that important information must be given and received, via radios and internally in the driver's cabin and patient cabin. iriSound Intercom ensures that all communication takes place in a secure manner and that no vital information is lost or misunderstood.

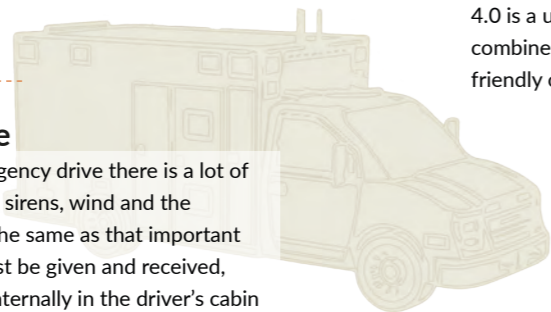

Armored vehicle

Armored vehicles are often very noisy while driving and communicating with the outside world can be vastly improved by installing an iriSound intercom system.

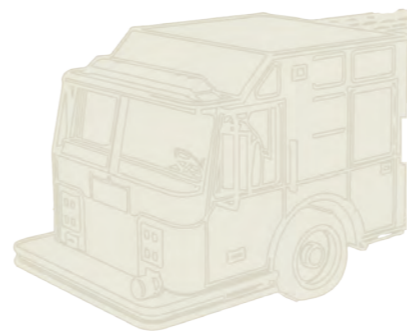
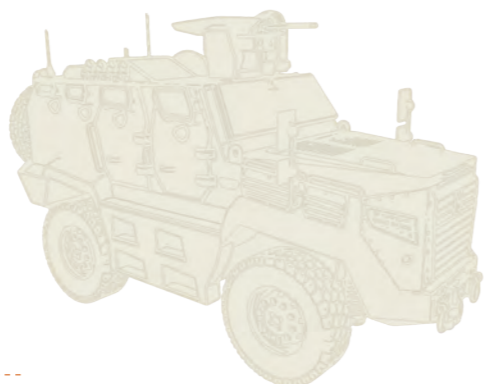

Fire truck

Working with chemicals or smoke, requires a respiration mask. The respiration mask is an audio obstacle and reduces the audio quality significantly. Most common scenario is that 2 users are working in a pair while being able to communicate in Full Duplex, and also being able to listen to the external radio. When the radio needs to be answered, a large easy access PTT is needed

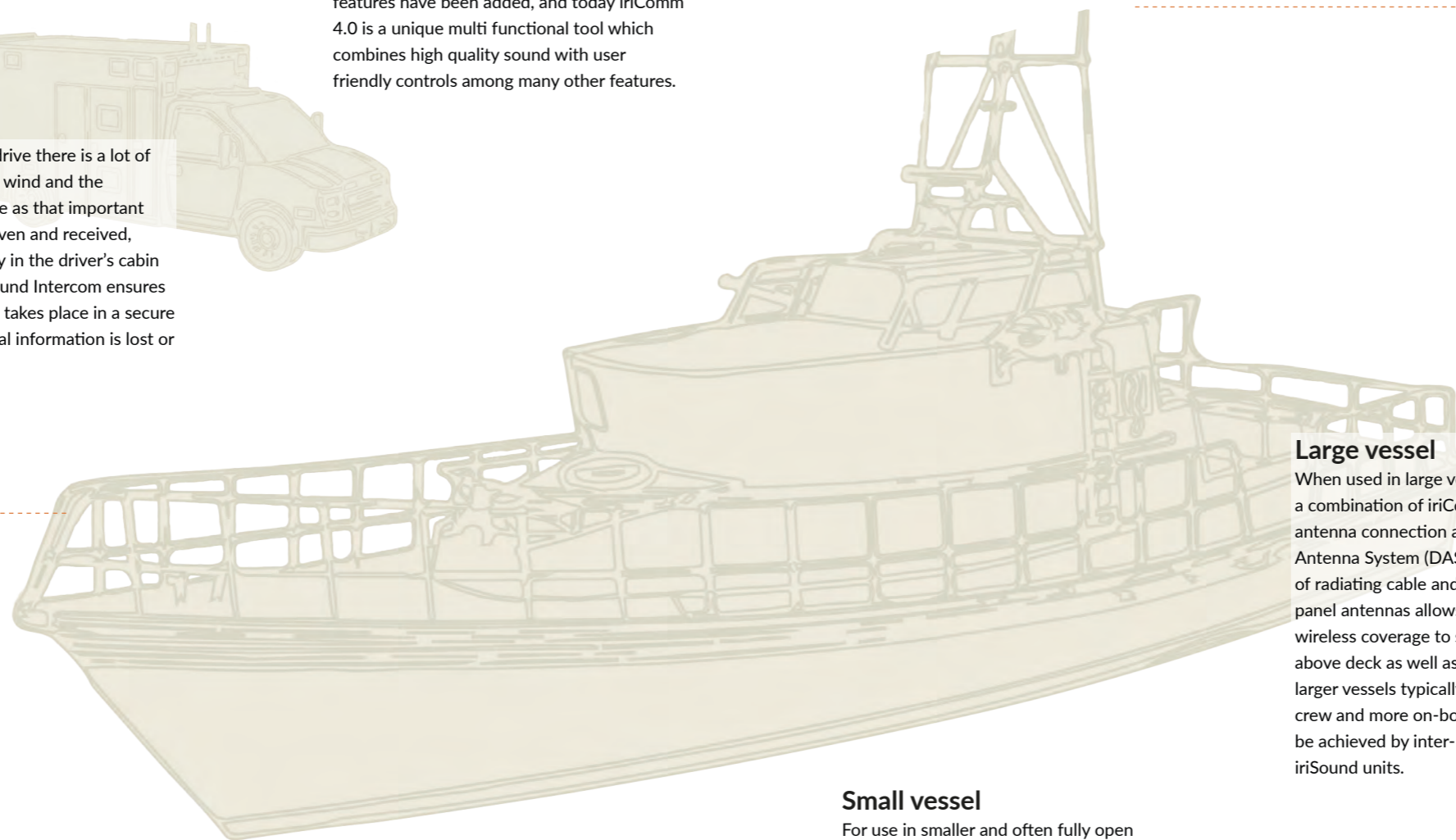
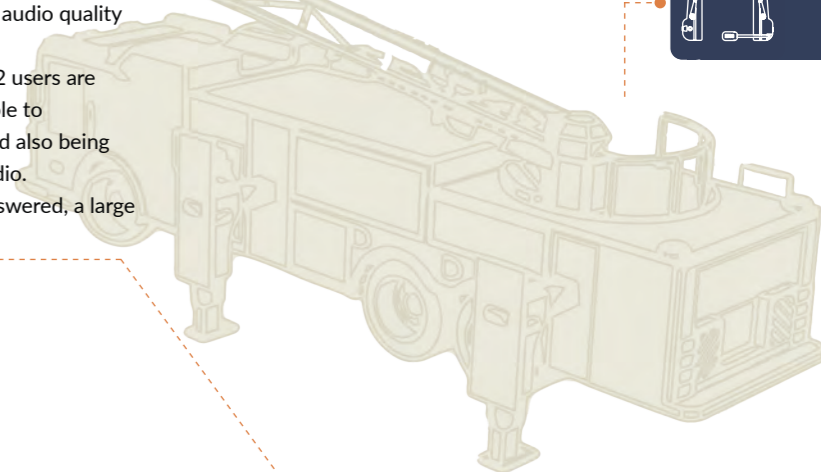

Large vessel

When used in large vessels (typically >20m) a combination of iriConnect with external antenna connection and a Distributed Antenna System (DAS) consisting of lengths of radiating cable and omni-directional- or panel antennas allows you to tailor the wireless coverage to suit your purpose - above deck as well as below. Intercom in larger vessels typically incorporate a larger crew and more on-board radios. This can be achieved by inter- connecting multiple iriSound units.

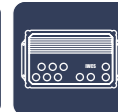

Small vessel

For use in smaller and often fully open vessels, all the iriSound intercom components are designed to withstand the marine environment. A range of iriConnect wireless connection points is available to meet a variety of wireless coverage scenarios.

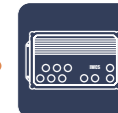
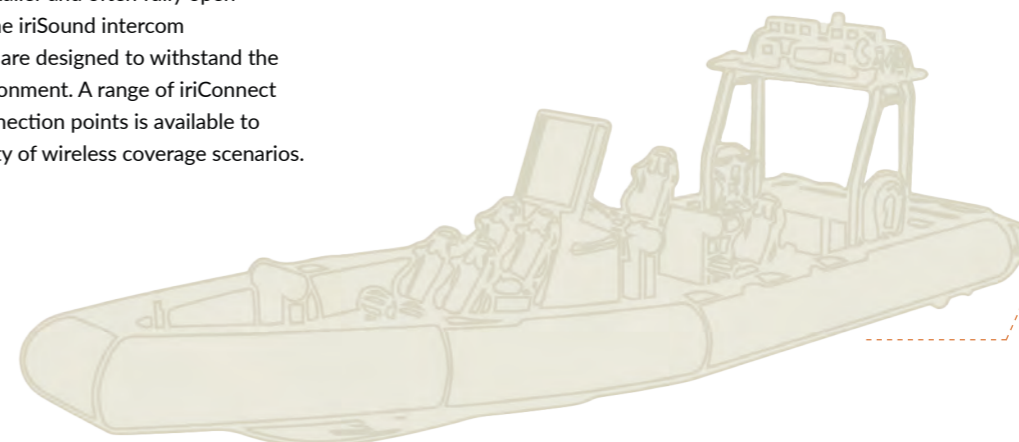



” Clear sound and wireless helps immensely with movement around the RIB the functionality of being able to isolate different crew members to transmit on the radio

- Port William Inshore Rescue

iriBelt MKIII

iriBelt is a pocket-sized wireless transceiver predominantly used in connection with iriInsert for wireless intercom using closed marine safety helmets (e.g. Gecko). iriBelt can also be used with 3rd party headsets or, in special cases, a waterproof in-ear headset.

iriBelt supports one primary and one secondary wireless connection. When used in a full-duplex intercom setup, the primary connection is used for the intercom. The secondary can be paired with a cell phone or a handheld radio, or it can simply be left unpaired.

iriBelt has an advanced inductive battery charge circuit. The 800 mAh Li-Ion battery provides long life and long operational time - up to 24 hours.



iriInsert

iriInsert is a high-quality audio insert originally designed for use with the Gecko MK11 marine safety helmet. Today it is also being used with other helmet models. iriInsert consists of a waterproof, high-quality, noise canceling boom microphone and either one or two waterproof speaker units. iriInsert comes in a plethora of configurations to suit the vast number of different handheld radios in the market.

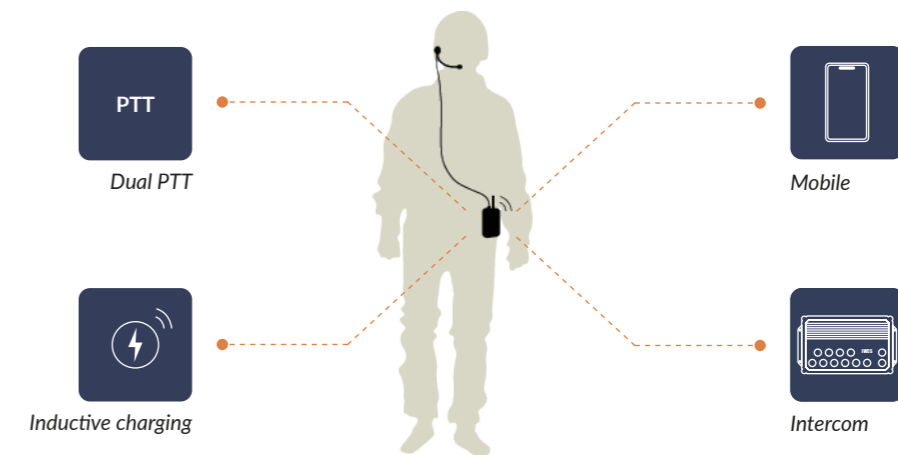



” For many years I drove without any means of communications during races. Now I cannot live without it - it changes everything.

- Rasmus Koch Hansen / European champion and 3rd in the world championship parallel slalom, Team Lindbergh Racing

Research and Development

IWCS Unique Solutions

Over the years, by servicing customers like Search & Rescue teams, Firefighters, Navy/Marine and helicopter rescue services world wide, we have become well aware of the special nature of these people's daily challenges. We have listened to them and designed our products to meet their specific needs.

IWCS have electronics and mechanical designers, and our solutions are designed and engineered all the way from initial drawings to selecting the boxes products are shipped in. Our well equipped facilities include CNC controlled machinery and 3D printing for prototyping and production of small volume, customer specific units.

Besides our standard products in the iriSound and iriComm families, we also provide customer specific solutions and turnkey projects. We have in-house test facilities allowing us to simulate depths down to 50m, and can offer product development to meet very unique offshore and sub-surface requirements - e.g. customized diver-to-diver and diver-to-surface communication systems.

Case story

Over the years, by servicing customers like Search & Rescue teams, Team Lindbergh Racing is in the absolute world elite in both Jet Ski and RunAbout and when competing with professional teams from the Middle East and the USA, the details become crucial.

In collaboration with Team Lindbergh Racing, IWCS has designed and developed communication that fits the racing helmets, so that the driver and mechanic can communicate during training and races. Developers from IWCS were trained to handle these racing machines to understand the challenges and demands of this development. The high noise conditions combined with salt water require a great understanding of the element, which can not only be achieved theoretically - IWCS was in it all the way.

”IWCS made it possible for me to speak with the team during the races - it has a big impact in the races how we are able to communicate and understand each other - we are able to change strategy during a race and turn things into a win.

For many years I drove without any means of communications during races. Now I cannot live without it - it changes everything”

- Rasmus Koch Hansen / European champion and 3rd in the world championship parallel slalom, Team Lindbergh Racing

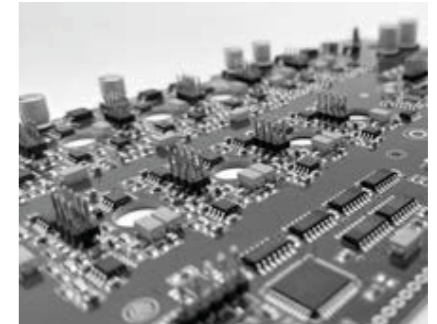



” At the core of the ProZero series for professionals lies a foundation of cutting-edge technology and unmatched robustness.

- Jonas Pedersen / CEO Tuco Marine Group

Specifications

iriComm 4.0 wireless	Headband	Helmet
Connection	Wireless 2,4 GHz	
Weight	415 g	330 g
Waterproof	IP67	
No. of PTTs	2	
3-Mode LED	Yes	Yes
Situational Awareness	Yes	Yes
Battery	700 mAh Li-Ion Rechargeable and replacable	
Charging	USB	
Charge time	< 3 hours	
Earpads	Memory Foam	
SNR	> 25dB	
Frequency range	100 - 8000 Hz	
Storage temperature	-20 C to + 50 C	
Part number	IR-35-2112-01-xxxxx	IR-35-2212-01-xxxxx

iriComm 4.0 wired	Headband	Helmet	Headband - PLUS	Helmet - PLUS
Weight	365 g*	295 g*	375 g*	305 g*
Waterproof	IP67			
No. of PTTs	1			
3-Mode LED	-	-	Yes	Yes
Situational Awareness	-	-	Yes	Yes
Battery			430 mAh Li-Ion Rechargeable	430 mAh Li-Ion Rechargeable
Charging	USB			
Charge time	< 2 hours			
Gel earpads	Standard			
SNR	> 25dB			
Frequency range	100 - 8000 Hz			
Storage temperature	-20 C to + 50 C			
Part number	IR-35-1111-01-xxxxx	IR-35-1211-01-xxxxx	IR-35-1112-01-xxxxx	IR-35-1212-01-xxxxx

*cable weight not included

DSP Mixer	irisound 4	iriSound 6	iriSound 8
Audio/data channels	4	6	8
AUX ports	2		
Weight	500 g		
Size	230/250 x 145 x 50/65		
Waterproof	IP67		
Power	12 VDC / 300mAh	12 VDC / 450mAh	12 VDC / 600mAh
Temperature range	-20 C to +65 C		
Frequency range	20 - 20.000 Hz		
Part number	IR-14-0300-01	IR-16-0300-01	IR-18-0300-01

iriSelect	
Weight	350 g
Size	110 x 75 x 50 mm
Waterproof	IP67
Temperature range	-20 to +60 °C
Connectivity	IWCS Bus
No. of PTTs	4
Audio modes	Up tp 10
NVG compatible	NVIS Class B (optional)
Power Supply	5 VDC (from iriSound)
Part number	IR-20-1040-02

iriSelect Black Box	
Weight	350 g
Size	110 x 75 x 50 mm
Waterproof	IP67
Temperature range	-20 to +60 °C
Power Supply	IWCS Bus
Part number	IR-20-104_-01

iriConnect	Internal Antenna	External Antenna	External Antenna Connection
Weight	225g	250g	225g
Size	110x75x50 mm	210x75x50 mm	110x75x50 mm
Radio	2,4 GHz		
Waterproof	IP67		
Temperature range	-20 to +60 °C		
Connectivity	IWCS Bus		
Audio resolution	16 bits		
Frequency range	20 - 20.000 Hz		
Power Supply	Powered by iriSound		
Antenna	-	3dBi dipole	RPTNC (male)
Part number	IR-20-1050_-0_	IR-20-1053_-0_	IR-20-1051_-0_

iriStore	
Weight	150 g
Size	50x75x50 mm
Waterproof	IP67
Temperature range	-30 - +60 °C
Power Supply	IWCS Bus
Storage medium	USB drive <32 GB
Part number	IR-20-1100-01

Radio Interface	
Weight	230 g (excl. cable)
Size	110x75x50 mm
Waterproof	IP67
Temperature range	-30 to +60 °C
Connectivity	IWCS Bus
Frequency range	20 - 20.000 Hz
Power Supply	IWCS Bus
Part number	IR-20-1071.03-_____

Headset Connection Panel	
Weight	100 g*
Size	Ø 60 mm
Waterproof	IP67
Temperature range	-30 to +60 °C
Part number	IR-40-4011-0X-_____

Headset Interface	
Weight	250 g
Size	50 x 75 x 50 mm
Waterproof	IP67
Temperature range	-30 to +60 °C
Power Supply	IWCS Bus
Audio resolution	Analogue, 20 - 20.000 Hz
Headset Signal	Speaker: 150mW into 8Ohms Microphone: 5mV nominal, electret
NVG compatible	NVIS Class B (optional)
Power Supply	IWCS Bus
Part number	IR-20-1420-01-xxxxx

iriBoost	
Weight	230 g
Size	110x75x50 mm
Waterproof	IP67
Temperature range	-30 to +60 °C
Audio resolution	20 - 20.000 Hz
Interfaces	1 x PWR (12 VDC)
Power Supply	10-16 VDC / 10A (max)
Part number	IR-20-1220-01

iriInsert	Single	Dual
Weight	200 g	250 g
Size	Ø 50 x 40 mm	Ø50 x 40 mm x2
Waterproof	IP67	
Temperature range	-30 to +60 °C	
PTT	Optional	
Microphone	Left or right	
Audio	Speaker:200 - 8.000Hz Military grade, noise canceling boom microphone. Voltage supply from radio	
Termination	Spiral cable with connector for iriBelt or radio specific connector for direct radio connection	
Part number	IR-33-00xx_-0x-_____	IR-33-00xx_-0x-_____

Active Splitter	No Battery	Battery
Weight	300 g	300 g
Size	120x45x45 mm	120x45x45 mm
Waterproof	IP 54	IP 54
Temperature range	-30 - +60 °C	-30 - +60 °C
Headset connector	2x TJ 108	2x TJ 120
ICS connector	TP 108	TP 120
MIC impedance	H/L	H/L
MIC type	DYN / amplified	DYN / amplified
Part number	IR-46-TX108-01-____	IR-46-TX120-01-____

iriBridge	iriBridge	iriBridge R
Weight	600 g	800 g
Radio	2,4 GHz	2,4 GHz
Waterproof	IP67	IP67
Temperature range	-30 to +60 °C	-30 to +60 °C
Power	+10 - 18 VDC	+10 - 18 VDC
Antenna connector	SMA	SMA
Wireless range	>100 m LOS	>100 m LOS
Part number	IR-20-1061-01	IR-20-1060-01-xxxxx

iriBelt	
Weight	300 g
Radio	2,4 GHz
Waterproof	IP67
Temperature range	-30 to +60 °C
Standard range	Up to 50 meters LOS
Long range	Up to 250 meters LOS
No. of PTTs	2
Battery	430 mAh Li-Ion
Charging	Inductive, USB
Inductive charge time	<4 hours
SNR	20 - 20.000 Hz
Part number	IR-20-2012OBK-01-xxxxx

Radio interfaces handheld

IWCS interface to many different handheld and mobile radios.

Below is listed a selection of radios IWCS supports. The list is dynamic and constantly being updated. If your selected radio is not present contact your local dealer or our engineers directly.

Axnes
Harris
AN-PRC-152
Hytera
TC2100, YC2108, TC500, TC580, TC600, TC610, TC620, TC700, TC1600, PD502, TC2100, TC500, TC600, TC610, TC620, TC700, TC1600, PD506, PD406, PD402, PD465, PD415, PD505, PD700, PD780, PD780G, PD785, PD705, PD786, PT580, PD782, PD702, PD702G, PT580H, Digital x1e/x1p/PD602/PD600, PD605G, PD605, PD665, PD665G, PD685, PD685G, TC-320, TC-780, TC-610P, PD372, PD37X, PD36X, PD35X, TD350, TD360, TD370
Icom
IC-F3, IC-F3S, IC-F4, IC-F4S, IC-F10, IC-F20, IC-H2, IC-H6, IC-J12, IC-M5, IC-U12, IC-U16, IC-40, IC-F3G, IC-F3GS, IC-G3GT, IC-F4G, IC-F4GS, IC-F4GT, IC-F43GS, IC-F43GT, IC-F43TR, IC-F11, IC-F11S, IC-F14, IC-F14S, IC-F15, IC-F21, IC-F21S, IC-F22, IC-F24, IC-F24S, IC-F31, IC-F33, IC-F43, IC-V8, IC-V80, IC-F3G, IC-F3GS, IC-G3GT, IC-F4G, IC-F4GS, IC-F4GT, IC-F43GS, IC-F43GT, IC-F43TR, IC-F11, IC-F11S, IC-F14, IC-F14S, IC-F15, IC-F21, IC-F21S, IC-F22, IC-F24, IC-F24S, IC-F31, IC-F33, IC-F43, IC-V8, IC-V80, IC-F1000, IC-F2000., IC-F50, IC-F51, IC-F60, IC-F61, IC-F30G, IC-F30GT, IC-F30GS, IC-F31GS, IC-F31GT, IC-F31, IC-F33G, IC-F43G, IC-F43TR, IC-M87, IC-M88, IC-F3262D,F4262D Series (14pin), IC-F4262DT/DS, IC-F4400DS
Kenwood
TK208, TK220, TK240, TK248, TK250, TK260G, TK270, TK270G, TK308, TK340, TK350, TK430, TK2100, TK2207, TK3201,TK330, TK3107, TK3207, TK3160, TC265, TC270, TC365, TC366, TC380, TK3302, TK3000, NX340, TK2140, TK3140, TK3180, TK280, TK380, TK385, TK480, TK481, TK190, TK290, TK390, TK2180, TK3180, TK2212, TK5210, TK5400, Nexedge NX200, NX300, PKT-23 Protalk Radio, TPZ-D553, UBZ-M31, UBZ-M51L/S, TK-3601D, PKT-3601, NX-P500, WD-K10TR, WD-K10PBS
Maxon/Midland/Legacy
MAXON: SL25, SL55, SP100, SP120, SP130, SP140., Midland: LXT410, GXT500, GXT710., MAXON: SL100, SP200, SP200K, SP210., Legacy: PL1145, PL2245, PL2215P, PL2245P, PL2415, PL5151, PL5164., MAXON:SL25, SL55, SP100, SP120, SP130, SP140, SP410, PL1145,PL2215 P,PL2245,PL2245P,PL2415,PL2445,PL5151,PL5161, PL5164,SP200
Motorola
CP88, CP040, CP100, CP140, CP150, CP160, CP200, CP1300, EP450, CT150, CT250, CT450, GP200, GP300, GP308, GP68, GP88, BC120, GTI, LTS2000, PR400, P040, P080, P110P1215, P1215LS, PRO3150, BPR40, CP1600, DP1400, DEP450, GP3688, GP3188, XIR-C2620, SP10, SP21, XTN446, XTN500, XTN600, PRO400, PRO1150, PRO2150, DTR650, DTR2350, DTR2450, XU1100, XU2600, GT1, CP100, PMR446, VL50, MTP700, GP1280, GP140, GP320, GP328, GP338, GP339, GP340, GP36, GP380, HT1250, HT1550, HT750, MTX850, MTX950, PRO5150, PRO5350, PRO5450, PRO5550, PRO5750, PRO7150, PRO7350, PRO7750, Tetra MTP810Ex, MTP850Ex, MTP700, PTX760, PTX700, PT9150, EX500, EX600, GL2000, GP328PLUS, GP338PLUS, GP344, GP388, PRO5150elite RELM: RPV30000, RPV3600, RPU3000, RPU3600, GP900, HT1000, JT1000, MT2000, MTS2000, MTX8000, MTX838, MTX900, MTX9000, MTX960, XTS2500, XTS3500, XTS5000, XTS3000, XTS500, XTS1500, EF Johnson:51SL, 5000series, 5100series, 7700series XTS1500, XTS4250, T5200, T5300, T5320, T5400, T5410, T5620, T5800, Tetra MTH650/800, i860, i710, i830, i530, i205, i730, i305, i315, i325, etc., Tetra MTH500, MTH650, MTH800, MH850, MTP850, MotoTRBO, XPR3600/6500/6550, XPR7350, XPR7550DP3400/3401/3600/3601/4000/4400/4401/4600/4601/4800, APX1000, APX2000, APX3000, APX4000, APX6000, APX7000, XIR P8620, XPR6000, XPR6300, XIR8661, XIR8628, XIR8668, MTP6550, MTP600 series APX800, MTP850S, P8620, P8268, P8600, P8608, P8660, DGP4150, DGP5050, DGP555, DGP6150, SL4000/4010, SL7550, SL1K, SL300, SL7590, DP2000/2400/2600, DP3440, DP3441, XPR3000/3300, XPR3500 MTP3250,TETRA MTP3100, MTP3200, MTP3250, MTP3100,MTP3200, XIR P6600, XIR P6608, XIR P6620, XIR P6628, MTP850FUG, MTP3550, DEP550, MTP3000, MTP3250, for CLP Series, CLP1010, CLP1040, CLP1060, Motorola ST7500, Motorola ST7500 (with 90 degree SR)
Nexus
Nexus 4pin male, 7mm diameter works with Nexus jacks

Sepura
SRP2000, SRP3000, SRH3500, SRH3800, SRP2000, SRP3000, SRH3500, SRH3800, STP8000.STP9000, STP8X Ex
Tetra/EADS
Tetrapol G2 (MC9620), TPH700, TPH700, THR9, THR9i, THR8, TH1N, EADS: TPH900
Thales
Vertex
VX-400, VX-410, VX-420, VX-160, VX10,VX130, VX160, VX168, VX180, VX210, VX210A, VX300, VX400, VX410, VX420, VX354, VX130, VX160, VX168, VX180, VX210, VX210A, VX300, VX400, VX410, VX420, VX424, VX354, VX230, VX231, VX454, EVX351, EVX534, EVX539, VX130, VX160, VX168, VX180, VX210, VX210A, VX300, VX400, VX410, VX420, VX424, VX354, VX230, VX231, VX454, EVX351, EVX534, EVX539, MH-360M, MH-450M, VH-110, VH115M, VH-120, VH-130, VH-215M, VX600, VX800, VX900, VX530, VX-6R, VX-7R, EVX-S24, IC-4300, IC-M25, FT-207R, VX820, VX821, VX824, VX829, VX920, VX921, VX924, VX929
Yaesu
FT-60R, VX-3R, FT-250R

Radio interfaces fixed

Alinco
DR635
EADS
TMR880i
Elman
RTV-1077D
EMC
DMR-U450, DMR-V070, DMR-V160
Entel
DX4XX, HT6XX, HX4XX
Excera
EM8100
Furuno
FM4721
Garmin
200/200i, 215/215i
Icom
IC-M33, IC-M35, IC-M37, IC-M423, IC-M506-rear, IC-M60X, IC-M73, IC-M91
JRC
JHS-800S

Kenwood
NX700, TK71XX/TK81XX
Motorola
ATX, DM4000, GM3600, MTM5400, MTM800
Peitel
PTCarphone5
Raymarine
Ray63, Ray73
Sailor
62XX, RT20XX, RT40XX
Schnoor
SAR-COM
Sepura
SRG3900
Simrad
RD68, RS35, RS40
Standard Horizon
GX-1700, GX-5000
Teltronic
MDT-400





IWCS ApS • Hejrevang 13, 3450 Allerød, Denmark •
www.iwcs.eu • +45 43 43 26 26 • info@iwcs.eu