



ROGER™

GNSS repeater

Time2Act™

**Roger-GPS Ltd.
Company specialized in
GNSS repeating
and RF over Fiber (RFoF)
technology**



Copyright Roger-GPS Ltd. ©

Read more about our solutions from www.gps-repeating.com

Roger-GPS Ltd - Time2Act



The increasing popularity of devices and applications being able to navigate fast has given rise to expectations that the devices would be able to operate indoors as well. Positioning system solutions are widely used in all communication networks including Mission Critical operations from public safety to transport. All networks use the GNSS -navigation signal for time synchronization.

ROGER-GPS is specialized in Global Navigation Satellite System (GNSS) repeating technology. GNSS comprises systems such as GPS, Glonass, Galileo and BeiDou. ROGER-GPS proven system concept enables the use of GNSS repeater devices and services in places where it was previously impossible. Our customers include a wide range of users who need GNSS signal reception or time synchronization. Users like telecom, public safety, defense, transport, airlines, logistics and companies manufacturing, selling and servicing GNSS systems, receivers, terminals and services.

ROGER-GPS is the leading European manufacturer of GNSS solutions worldwide. In September 2008 ROGER-GPS got acceptance of the world first type approved, CE-certified GPS repeater product by the communications authority. ROGER-GPS provides repeaters, splitters and amplifiers for GPS L1, L2, Glonass L1 and Galileo satellite signals. The products are manufactured in Finland and used in all continents through our worldwide distribution network.

In 2015 ROGER-GPS introduced first in the world two new concepts into the market:

- Leaky feeder cable GNSS repeater solution, possibility to use leaky feeder cable allowing e.g. tunnel and wide indoor area coverage.
- RF over Fiber solutions – possibility to extend the distance from the GNSS antenna even up to 16km and distribute the signal with fiber splitters to areas and applications like IP network synchronization -IEEE 1588 Precision Time Protocol (PTP) and Network Time Protocol (NTP) applications.



It is Time2Act and make sure with ROGER-GPS that your GNSS service is on the cutting edge.

What is ROGER™ GNSS Repeater?

ROGER™ GNSS (Global Navigation Satellite System) repeater operates by receiving GNSS satellite signals with an antenna located outdoor and re-radiating the signals to the indoor area or covered space.

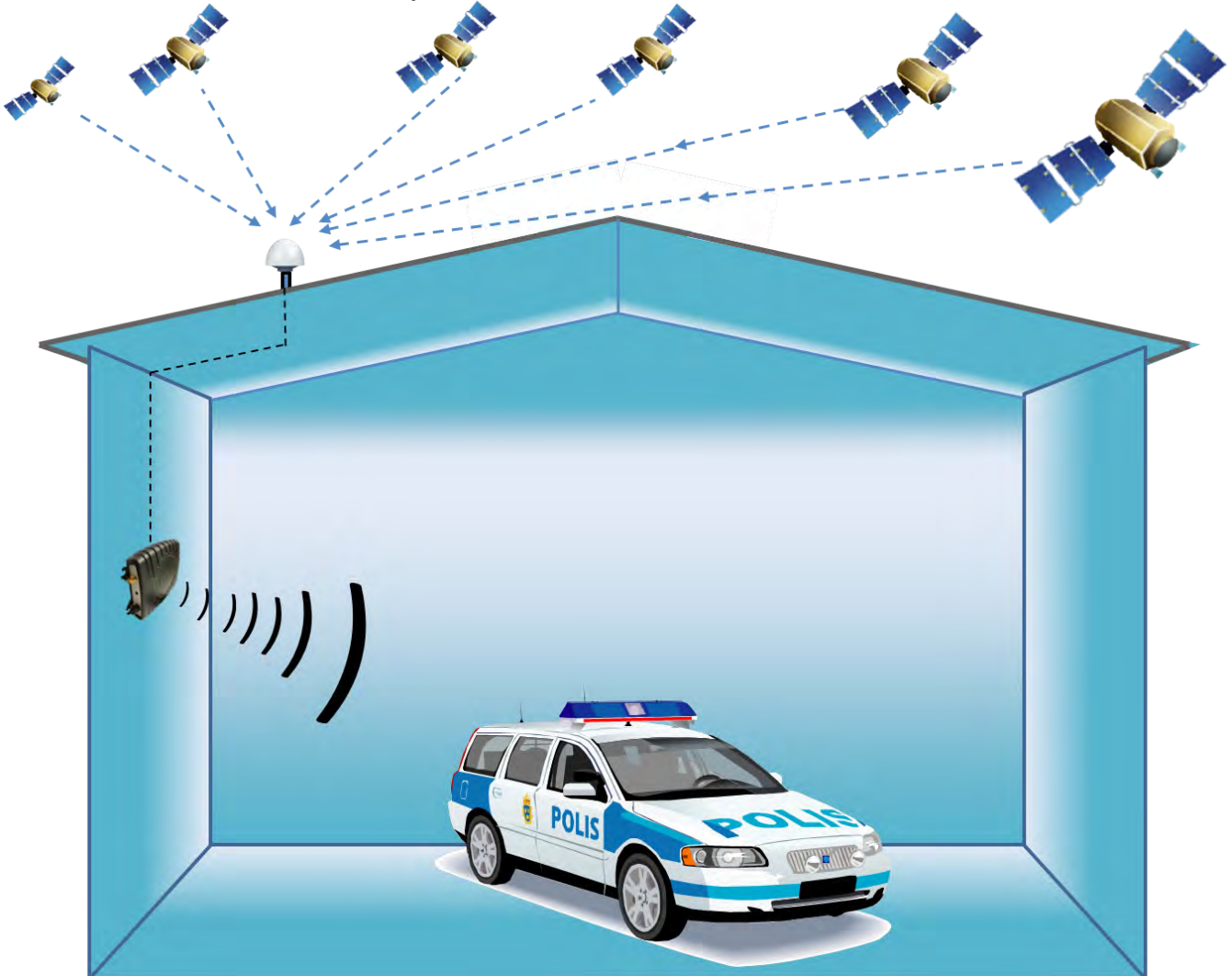

To use GNSS satellite devices inside your building you will need a repeater system to transfer the outdoor signals to inside. A repeater is a device that relays GNSS signals to any indoor location that isn't normally reachable.

The GNSS receiver is tracking the GNSS signal by using the re-radiated signal from the ROGER™ GNSS repeater. When the GNSS receiver is moved from repeater covered area to outdoors, the receiver will instantly track the location instead of the time consuming acquisition of GNSS almanac data.

Look our 90 sec. introduction:

<https://youtu.be/bzgJNHRRImk> or use QR-code



Copyright Roger-GPS Ltd. ©

Read more about our solutions from www.gps-repeating.com



IP67 Product Range

GNSS-L1G1GA-IP67 and
GNSS-L1L2G1GA-67

IP67 range Roger repeaters cover GPS L1&L2, GLONASS and GALILEO satellite signals. IP67 products are easy to install even in harsh conditions. This makes them ideal for places like car parks, tunnels or any wet and dusty places.



GNSS-S, GNSS-S2, GNSS-AS and GNSS-A

With the ROGER™ GNSS signal splitters and amplifiers it is easy to extend distance from an antenna or add more repeaters to extend coverage in a building.

DC/DC and AC/DC Power distributor

Roger™ GNSS DC Power Distribution is designed to be used with Roger GNSS repeaters. Roger™ GNSS AC/DC Power Distribution can provide power up to 5 Roger GNSS repeaters from one AC power outlet.



Copyright Roger-GPS Ltd. ©



Read more about our solutions from www.gps-repeating.com



IP51 Product Range

GNSS-L1G1GA and GPSR-1

IP51 range Roger repeaters cover GPS, GALILEO and GLONASS satellite signals. IP51 products are easy to install in controlled conditions. This makes them ideal for places like offices, workshops, demo areas, exhibition centers, etc.



GNSS-S, GNSS-S2, GNSS-AS and GNSS-A

With the ROGER™ GNSS signal splitters and amplifiers it is easy to extend distance from an antenna or add more repeaters to extend coverage in a building.



DC/DC and AC/DC Power solutions

Roger™ GNSS DC Power Distribution is designed to be used with Roger GNSS repeaters. Roger™ GNSS AC/DC Power Distribution can provide power up to 5 Roger GNSS repeaters from one AC power outlet. AC/DC 100-240V and DC/DC 12/24VDC also available.

Copyright Roger-GPS Ltd. ©



Read more about our solutions from www.gps-repeating.com



Leaky Feeder cable solutions

Leaky feeder

A leaky feeder system consists of a coaxial cable which emits functioning as an extended antenna. The cable is “leaky” in that it has gaps or slots in its outer conductor to allow the radio signal to leak into or out of the cable along its entire length.

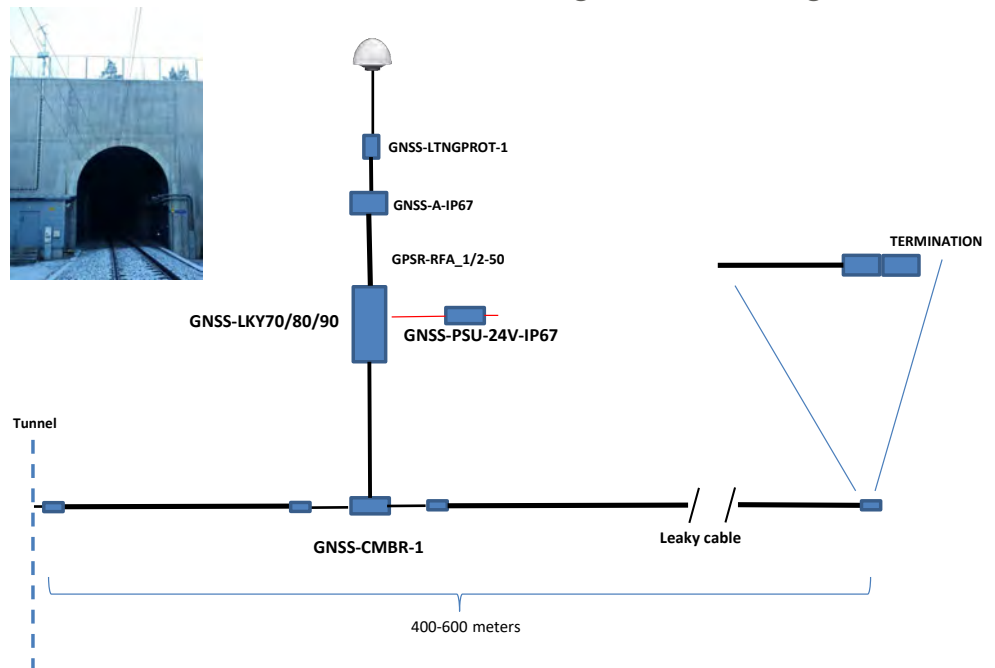

Copyright Roger-GPS Ltd. ©

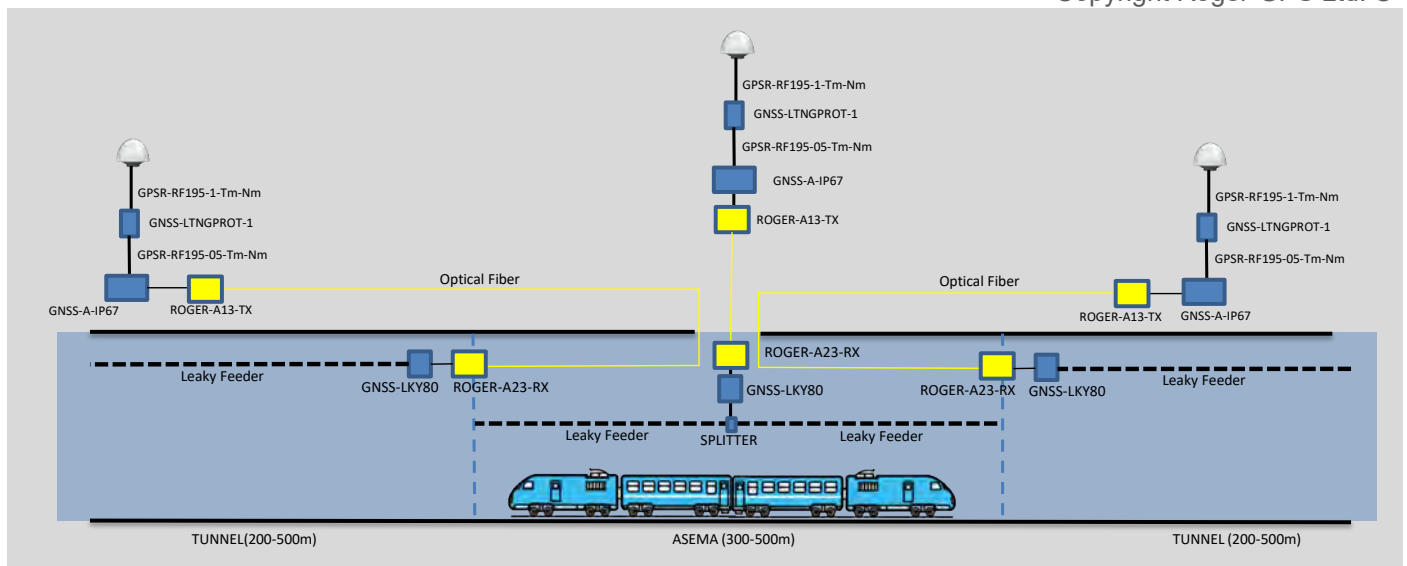

NEW!!

ROGER™
GNSS repeater

CE APPROVED

Instant GPS / GALILEO / GLONASS service indoors

New way to create GNSS coverage GNSS-L1G1GA-CHAIN-Y

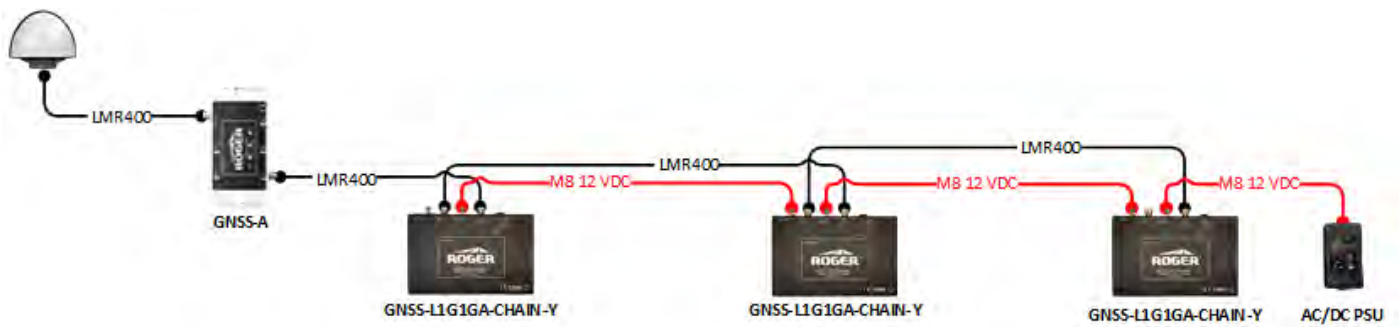

Key features

- One or multiple power supplies
- Simple cabling - quick installation
- Easily extendable - two RF outputs each +4 dB gain
- Automatic gain limitation for the repeater
- Oscillation prevention with indicator
- Maximal coverage for CE approved repeater
- Instant GPS/GALILEO/GLONASS fix when moving indoors and outdoors
- Full product family with repeaters, amplifiers and splitters

Fire stations, bus stations, railway stations, tunnels, aircraft hangars, etc.



Copyright Roger-GPS Ltd. ©

Read more about our solutions from www.gps-repeating.com

GNSS RF Over Fiber Links

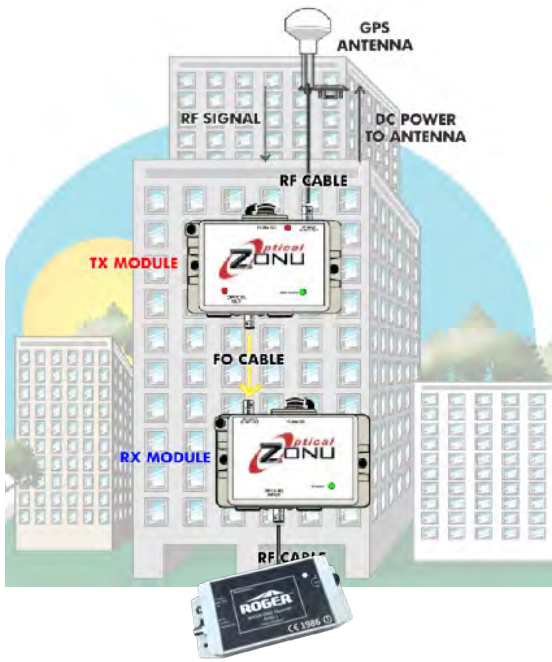

Point to point connections

- Using existing fibers in building
- Electrical isolation from lightning strikes
- Long distances (upto 16 km)

Daisy chain connections

- Extending the range to tens of kilometers
- Option to bypass or cover intrinsically safe areas
- Applications include underground mine and other long tunnels.

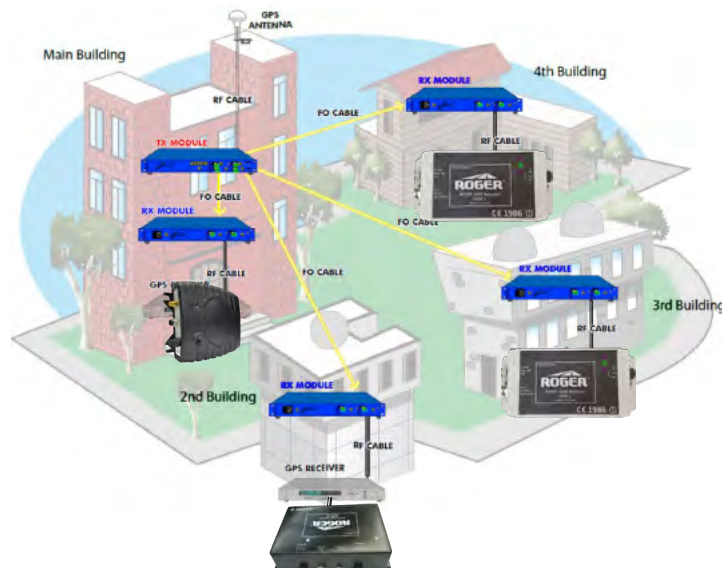
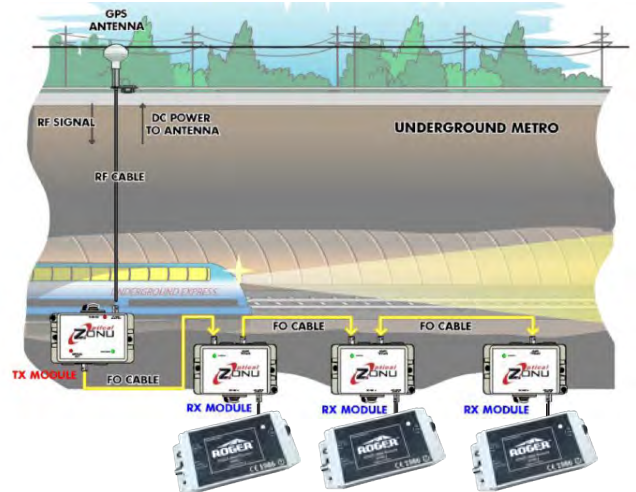

Star configurations

- Distributing the single point GNSS signal e.g. to timing instrumentation in campus or factory area



Tactical (OPSEC) Repeater Kit GNSS-TAC-H

Key Features

Use cases include MISSION CRITICAL and other PUBLIC SAFETY related services, whether it is location or timing related applications.

Everything you need for indoor GNSS in one compact case.

Open the lid and setup the antenna and you are ready to go.

No need for fixed power connection when using battery.

ASK FOR L1L2 OPTION - THE TACTICAL AIRFORCE LUGGAGE

Includes:

1. GNSS-L1G1GA repeater
2. 230V Power supply for charging the battery pack and powering up the repeater
3. Battery pack (8 Ah) if no power is available
4. The suction holder for L-mount bracket
5. GNSS antenna and 20m or 40m cable on reel
6. Reel holder for winding/unwinding of cable
7. Fuse for over current protection
8. 12V Power supply for AC/DC input and car battery/cigarette lighter adapter

Weight: 6,9 kg
 Size: 46.23 x 34.04 x 17.02cm
 (18.20" x 13.40" x 6.70")



Technical information:

GNSS-L1G1GA Repeater
 Frequency:

Overall Gain:
 Noise Figure:
 Adjustable attenuation:
 Impedance:
 Input connector:
 Operating temperature:
 Power supply:
 Battery pack:

Antenna power output:
 TX antenna gain max:

GPS L1 (1.57542 GHz)
 GLONASS L1 (1.602 GHz)
 GALILEO (1.57542 GHz)
 > 40dB
 < 2dB
 0-40dB
 50Ω
 TNC-female
 -25 - +75°C
 110-230VAC - 12VDC/1,0A
 Tracer BP2545 Lithium Polymer Battery Pack
 Battery Model: LiPo -6067100 3S2P 11.1V 8Ah
 +5VDC, 100mA
 +4dBd, RHCP polarization

Full GPS coverage inside car park (5 levels)

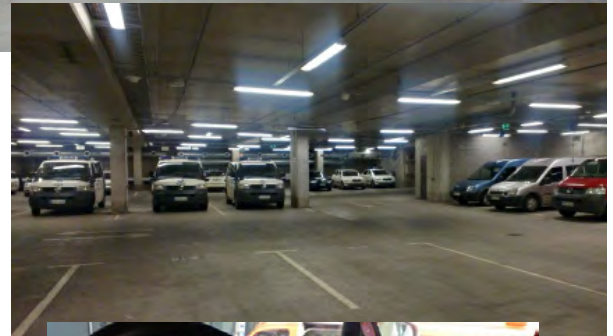
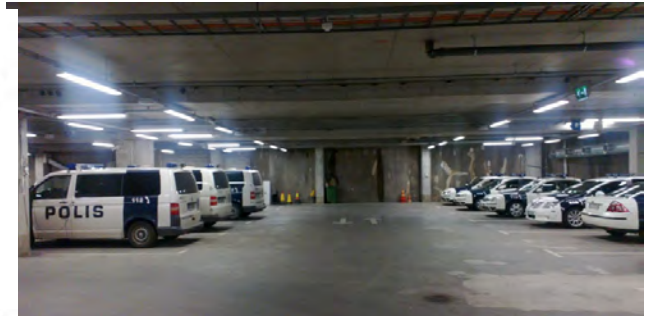
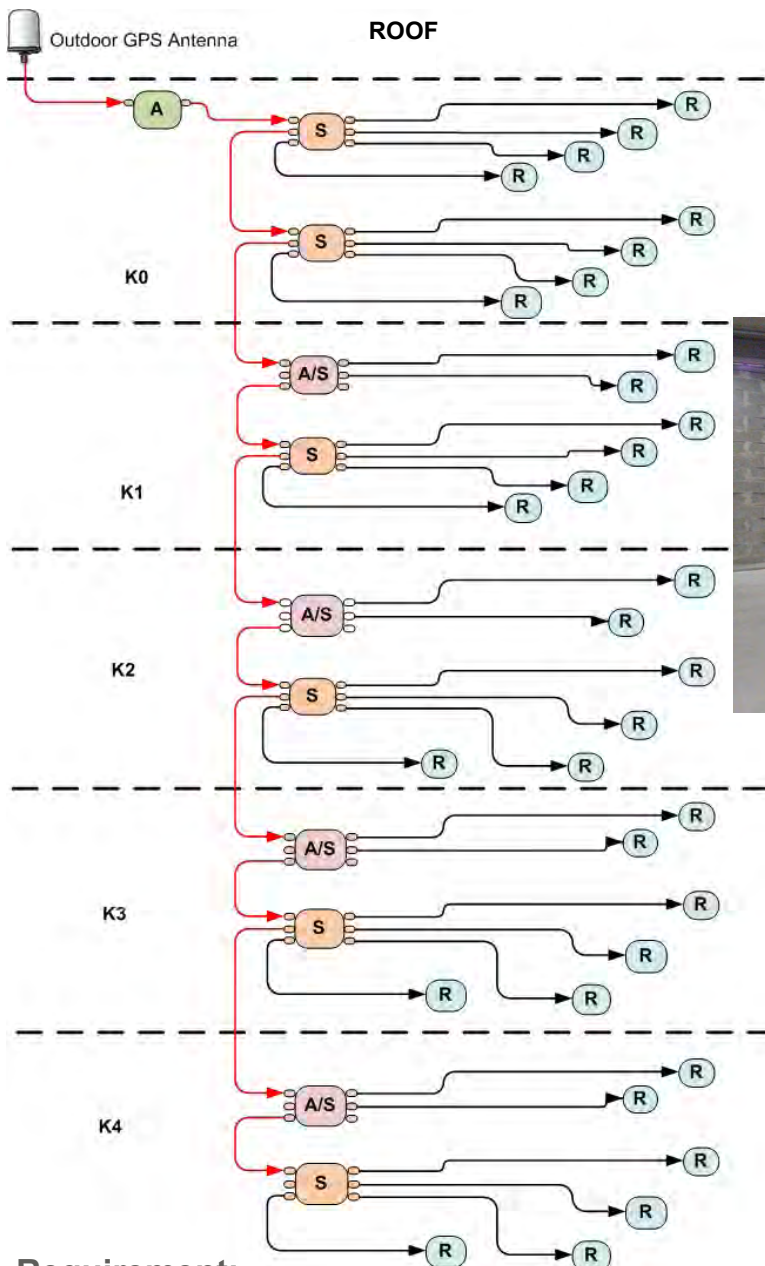

Requirement:

5 floors no GPS signal, Incident And Field Command System start up time 15 minutes when driving out.

Solution:

1 outdoor antenna, 31 repeaters, 6 Splitters, 4 Amplifier & Splitter, 100m trunk coax cable, 4-500m feed coax cable to repeaters. Incident and Field Command System start up time immediate.

Copyright Roger-GPS Ltd. ©



Case Study: Rescue Department

Roger-GPS repeater systems have increased the usability of the management system and the speed of the navigation function.

In 2006 the Päijät-Häme rescue department (Lahti Region Fire and Rescue Service) introduced a new incident management system. It soon became apparent that when the emergency services were inside the fire stations, the physical structure of the buildings was preventing ingress of GPS signals and vehicles were receiving and sending inaccurate location information.

Additionally, when the fire engines left the station, it would sometimes take several minutes to re-acquire a GPS satellite fix. During these first few crucial minutes of a callout the appliance would be transmitting incorrect location data to the command and control centre.

Solution

After a detailed study the rescue department made the decision to deploy Roger-GPS repeater systems inside all 24/7 manned stations and equipment halls. The repeater systems provide reliable and continuous GPS coverage inside the stations, which means that satellite navigation equipment in all vehicles is "locked on" to the GPS satellites at all times. When they leave the station they immediately acquire GPS lock and are able to transmit accurate location data to the command centre from the outset.

Marko Nieminen, ICT-Specialist at Päijät-Häme Rescue Department (www.phpela.fi) commented;

"The most important benefit is that the appliances no longer need to wait for a GPS 'fix' when they leave the station. They receive an accurate GPS signal at all times when inside which means that routing to the destination can be set before leaving the station (garage) if necessary. We have also installed GPS repeaters inside a number of training classrooms so that we can provide training on navigation systems indoors."

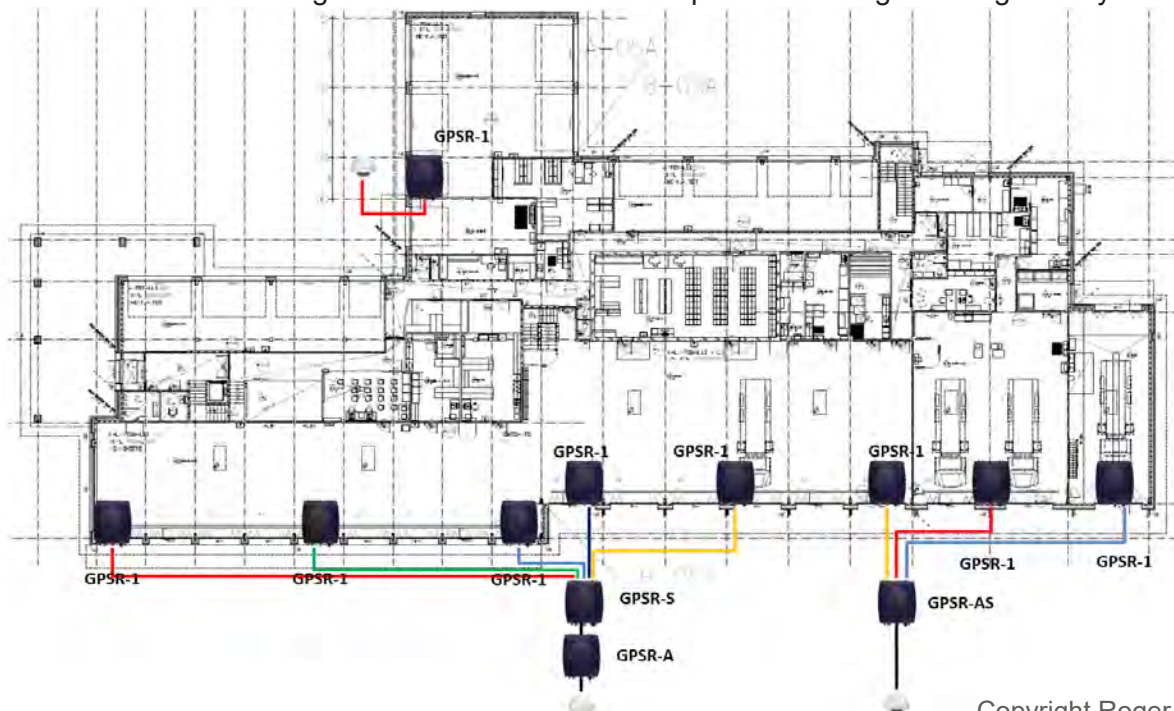

Copyright Roger-GPS Ltd. ©

Read more about our solutions from www.gps-repeating.com



ROGER™

GNSS repeater

**Contact us
or our world wide distributor network**

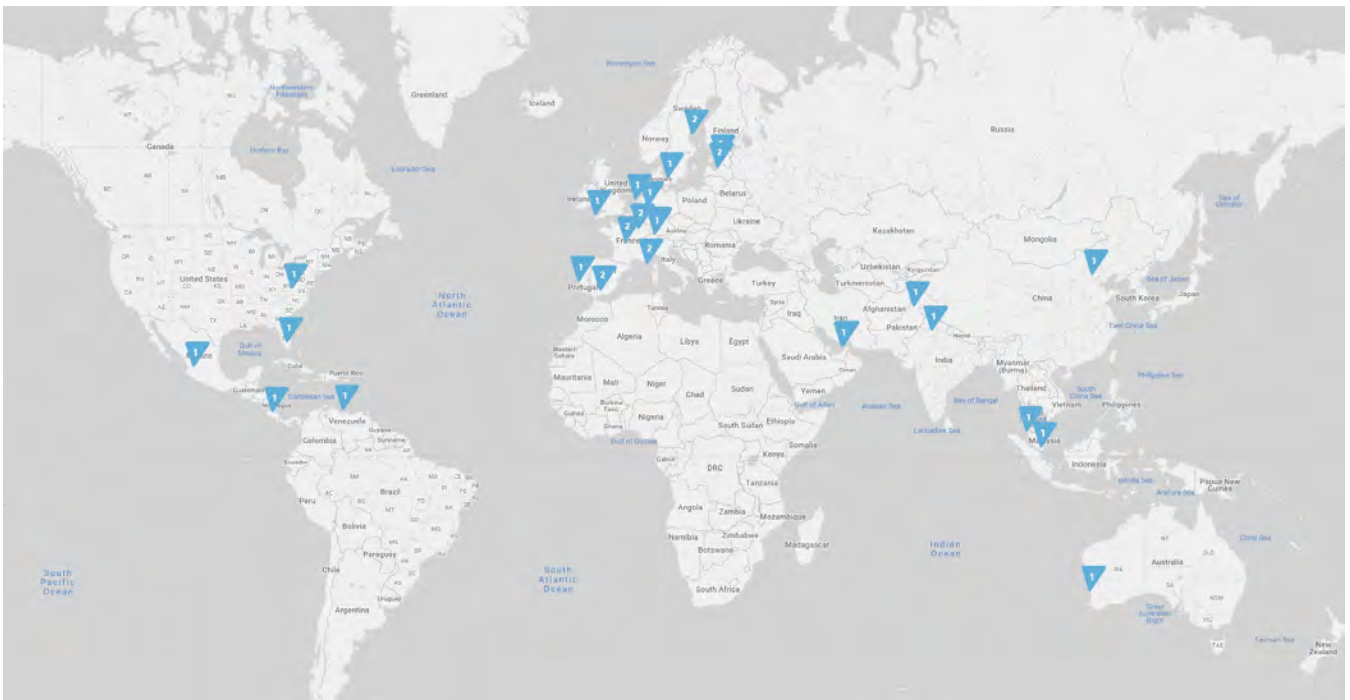

www.gps-repeating.com

roger@gps-repeating.com

